



www.tecfe.com

OPHTHALMIC PRODUCTS

Post-Operative & Post-Therapy Sunglasses & Eye Care Products:

- ◆ Post-Cataract Surgery Sunglasses & Kits
 - ◆ Low cost Polycarbonate Sunglasses
 - ◆ Premium Polarized Sunglasses
 - ◆ Post-Cataract Surgery Kits
- ◆ Post-Refractive Surgery Sunglasses & Kits
 - ◆ Low cost Polycarbonate Sunglasses
 - ◆ Premium Polarized Sunglasses
 - ◆ Post-Refractive Surgery Kits

Dual Eye Shields, Goggles, and Single Eye Shields

Dry Eye Products:

Moisture Retention Eyeshield
Punctum Plugs

EYESENTIAL® Dry Eye Sunglasses
Diagnostic Strips

Surgical Products:

- ◆ Microkeratome Blades & Tubing
- ◆ PVA & Cellulose Sponge Eye Products
- ◆ Surgical Marking Pen
- ◆ Ophthalmic Surgery Drapes
- ◆ Ophthalmic Cannulas
- ◆ Ophthalmic Knives & Blades
- ◆ Trepine Blades
- ◆ Assorted Hard-to-find Ophthalmic

EAR NOSE THROAT (E.N.T.) PRODUCTS

- ◆ Otological Ventilation Tubes
- ◆ MicroPick™ Ear Pick
- ◆ Eavey E3 Ear Wrap
- ◆ Head Bands
- ◆ Nasal Sponges
- ◆ Silicone Sheeting
- ◆ EpiStax™ Balloon Catheter
- ◆ Devilbiss® Atomizer
- ◆ Silicone "Ear Putty"® Plugs

GENERAL SURGICAL

- ◆ Infection Control Glasses, Goggles, Face Masks, and Face Shields
- ◆ General, Utility, and ACTI-Gard® Antimicrobial Surgery Drapes
- ◆ Surgical Skin Marker ◆ Transparent Dressings ◆ Adhesive Skin Closure Strips

CONSUMER PRODUCTS

- ◆ Digital LCD Thermometers, Bulk
- ◆ Silicone "Ear Putty"® Plugs
- ◆ PROVITA Smoke Hood
- ◆ Readers: Lighted, Bifocal, and Low Cost

Tecfen Corporation

5385 Hollister Avenue, No. 216
Santa Barbara, CA 93111 U.S.A

Tel: (805) 967 1153
Fax: (805) 967 1295

Home: www.tecfe.com
Email: tecfe@tecfe.com

Tecfen Corporation

5860-C Hollister Avenue
Santa Barbara, CA 93117 U.S.A

Tel: **(805) 967 1153**
Fax: **(805) 967 1295**

Home: www.tecfe.com
Email: tecfe@tecfe.com

SolarShield Post-Cataract Surgery Sunglasses

SolarShield® Fits Over



- Comfortable fit
- Lightweight frame
- Polycarbonate lenses provide 48% more protection from sunlight than ordinary sunglasses
- 100% UVA/UVB protection

29005A Smoke
Includes Black Vinyl Case

29005M Smoke
Includes protective foam

Ideal for post-cataract surgery patients



29009A Yellow



29008A Amber



29010A Clear

CE



5385 Hollister Avenue, No. 216
Santa Barbara, CA 93111 U.S.A.

Telephone: 805 967-1153
FAX: 805 967-1295

Website: www.tecfe.com
email: tecfe@tecfe.com

SolarShield LX[®] Polarized WEAR OVER, Premium Post- Cataract Surgery Sunglasses



**ESSENTIAL EYEWEAR
FITS OVER PRESCRIPTION GLASSES**



ADVANCED UV PROTECTION™

Lenses block 100% of harmful UVA and UVB light. Patented design blocks 48% more light than conventional frames—especially important to Post-Cataract & other light sensitive patients.

THE PERFECT FIT

- Lightweight frames with BendToFit™ temples for a custom fit on specific models
- Twelve shapes to fit all prescription frames. Fits over Rx frames not exceeding:

- 127mm x 36 mm **Oval**
- 129mm x 35 mm **Tapered Rectangle**
- 130mm x 33 mm **Soft Rectangle**
- 131mm x 35 mm **Angled Rectangle**
- 131mm x 40 mm **Round**
- 133mm x 38 mm **Mod Rectangle**
- 134mm x 41 mm **Mod Rectangle**
- 135mm x 34 mm **Hard Rectangle**
- 137mm x 42 mm **Soft Bowtie**
- 138mm x 50 mm **Square**
- 139mm x 42 mm **Tapered Square**
- 141mm x 52 mm **Aviator**



**17P204DLX
Display**

POLARIZED LENSES

Scratch-resistant PolarTX® lenses designed to eliminate harsh glare.



Oval



2B7X90A
Black Frame, Gray Lens



2B7X54TA
Tortoise Frame, Copper

Small



5385 Hollister Avenue, No. 216
Santa Barbara, CA 93111 U.S.A.

Telephone: 805 967-1153
FAX: 805 967-1295

Website: www.tecfe.com
email: tecfe@tecfe.com



Soft Rectangle



2G7X9029A
Black Frame, Gray Lens



2G7X5329TA
Tortoise Frame, Copper

Small



Mod Rectangle



25S7X00A
Black Frame, Gray Lens



25S7X04A
Black Frame, Copper Lens



25S7X50TA
Tortoise Frame, Gray Lens



25S7X54TA
Tortoise Frame, Copper

Medium



Mod Rectangle



2RM7X551TA
Tortoise Frame, Copper Lens

Medium/Large



5385 Hollister Avenue, No. 216
Santa Barbara, CA 93111 U.S.A.

Telephone: 805 967-1153
FAX: 805 967-1295

Website: www.tecfe.com
email: tecfe@tecfe.com



Hard Rectangle



2RH7X00A
Black Frame, Gray Lens

Large



Angled Rectangle



2Z7X01A
Black Frame, Gray Mirror

Medium



Tapered Rectangle



2Y7X01A
Black Frame, Gray Mirror

Medium



Soft Bowtie



2K7X9029A
Black Frame, Gray Lens



2K7X5529TA
Tortoise Frame, Copper Lens



5385 Hollister Avenue, No. 216
Santa Barbara, CA 93111 U.S.A.

Telephone: 805 967-1153
FAX: 805 967-1295

Website: www.tecfe.com
email: tecfe@tecfe.com



Tapered Square

2X7X01A
Black Frame, Gray Mirror

Large



Round

2C7X54TA
Tortoise Frame, Copper

Large



2117X00A
Black Frame, Gray

2117X04A
Black Frame, Copper

Square

Large



Extra Large

Aviator

237X00A
Black Frame, Gray Lens



Post Cataract Surgery Kits Premium - Deluxe - Economy

TE-671A Post Cataract PREMIUM SolarShield® Kit

- 29005A SolarShield® Sunglasses
- Drawstring Vinyl Case
- Half-Eye Reading Glasses, +2.50 Diopter*
- Clear Single Eye Shield
- Roll Transpore Tape
- Navy Vinyl Zipper Bag
[24cm x 16cm]

Minimum Order 100 Kits

*+1.00 to +4.00 Diopter in
+0.25 increments available - Please specify



PREMIUM

TE-671Z Post Cataract DELUXE SolarShield® Kit

- 29005M SolarShield® Sunglasses
- Foam Sleeve Case
- Sterile Eye Pad
- Clear Single Eye Shield
- Roll Transpore Tape
- Clear Plastic Vinyl Zipper Bag

Minimum Order 100 Kits



DELUXE

TE-671X Post Cataract ECONOMY SolarShield® Kit

- 29005M SolarShield® Sunglasses
- Foam Sleeve Case
- Clear Single Eye Shield
- Roll Transpore Tape
- Clear Plastic Drawstring Bag
[20cm x 25cm]

Minimum Order 200 Kits



ECONOMY



SolarComfort Post-Refractive Surgery Sunglasses



- Worn alone
- Lightweight, full coverage frames
- Ideal for dry-eye people
- Protective vinyl string case included
- UVA/UVB protection

6706A* Smoke Tint

Blocks 100% UVA/UVB to 400 nanometers

6706M Smoke Tint

*Also available in protective foam sleeve case



6707A Amber

Blocks 100% UVA/UVB to 520 nanometers



6709A Yellow

Blocks 100% UVA/UVB to 480 nanometers



6708A Clear

Blocks 100% UVA/UVB to 400 nanometers



Ideal for post-refractive surgery patients



CE

5385 Hollister Avenue, No. 216
Santa Barbara, CA 93111 U.S.A.

Telephone: 805 967-1153
FAX: 805 967-1295

Website: www.tecfe.com
email: tecfe@tecfe.com

Post-Refractive SolarComfort® Premium Sunglasses

Advanced UV Protection™ Polarized Lenses

Patented design blocks 48% more light than conventional frames, especially important to Post Lasik patients.

- Lenses block 100% of harmful UVA and UVB light.
- Wraparound lenses allow for maximum peripheral view.
- Lightweight frame for comfortable fit.



Obispo Rec 127 mm Frame, size (M)

6B13100A Black Frame, Gray Lens



6B13155TA Tortoise Frame, Copper Lens



Obispo Mod Shield 135mm Frame, size (L)

6BV5100A Black Frame, Gray Lens



6BV5109A Black Frame, Copper Silver Lens



Classic Mod Shield 127mm Frame, size (M)

6V3100A Black Frame, Gray Lens



6V3105A Black Frame, Copper Lens



Classic Shield 135mm Frame, size (L)

6U5101A Black Frame, Gray Lens



6U5105A Black Frame, Copper Lens



Post Refractive Surgery Kits Premium - Economy



PREMIUM

TE-671I PREMIUM Post Refractive Kit

- 6706A SolarComfort® Sunglasses
- Black Vinyl Drawstring Case
- 5818D Encore® Clear Dual Eyeshield
- Navy Vinyl Zipper Bag [24cm x 16cm]

Minimum Order 100 Kits



ECONOMY

TE-672X ECONOMY Post Refractive Kit

- 6706A SolarComfort® Sunglasses
- Foam Sleeve Case
- 5818D Encore® Clear Dual Eyeshield
- Packaged in clear drawstring bag

Minimum Order 150 Kits



6706A Sunglasses



5818D Dual Eyeshield



Dual Eyeshields, Goggles, Single Eye Shield & Moisture Chamber



Encore® Dual Eyeshield

Designed to be worn at night by post LASIK and cataract patients for maximum comfort & protection
Increases all-around optical visibility

**Adjustable to fit all head sizes • Latex free
Made of polycarbonate and durable single-cell foam**

5818D CLEAR

5819D SMOKE *with UV Protection*



Encore® Goggle Eyeshield

Polycarbonate lenses provide maximum protection and comfort for dry eye & post operative patients

**Adjustable head strap • Latex free
Hinged nose bridge provides added comfort
Durable foam on shield is slip proof & comfortable**

5820GS SMOKE with UV Protection

5821GC CLEAR *with UV Protection*



Encore® Single Eyeshield

Polycarbonate allows for maximum comfort and protection for post-operative patients

**Center design provides maximum optical clarity
Specially designed ventilation prevents fogging**

5702CS CLEAR



Encore® two-piece Eyeshield

Polycarbonate lenses provide maximum protection and comfort for post-operative patients

**Adjustable head strap
Durable foam is slip proof and comfortable
Latex free • Ventilated to reduce fogging**

5824MS CLEAR



Encore® Moisture Chamber

Designed to be worn at night to retain moisture for dry eye

**Adjustable to fit all head sizes
Made of polycarbonate and durable single-cell foam
Latex free**

5822MS CLEAR



Dry Eye Sunglasses, EYESENTIAL®



EYESENTIAL® Sunglasses

- 100% UVA/UVB protection
- Polycarbonate Lenses • Scratch Resistant
- Anti-Fog Coating • BendToFit™ Temples
- Foam lined frame retains moisture around the eye while protecting from external elements.
- Black vinyl drawstring case included
- Latex free



Square Frame

5F5559SF2A LARGE
Black Frame | Smoke Lens
5F5555F2TA LARGE
Tortoise Frame | Copper Lens



5F5659SF2A EXTRA LARGE
Black Frame | Smoke Lens
5F5655F2TA EXTRA LARGE
Tortoise Frame | Copper Lens



Mod Frame

5F359SF2A MEDIUM
Black Frame | Smoke Lens
5FX3555F2TA MEDIUM
Tortoise Frame | Copper Lens



5FX559SF2A LARGE
Black Frame | Smoke Lens
5FX5555F2TA LARGE
Tortoise Frame | Copper Lens



Oval Frame

5FS0500SF2A MEDIUM
Black Frame | Smoke Lens
5FS0555F2TA MEDIUM
Tortoise Frame | Copper Lens



Rectangle Frame

5F1050SF2A MEDIUM/LARGE
Black Frame | Smoke Lens
5F10555F2TA MEDIUM/LARGE
Tortoise Frame | Copper Lens



Provide a barrier to the eyes
for those suffering from dry eye



5385 Hollister Avenue, No. 216
Santa Barbara, CA 93111 U.S.A.

Telephone: 805 967-1153
FAX: 805 967-1295

Website: www.tecfe.com
email: tecfe@tecfe.com

Punctum Plugs

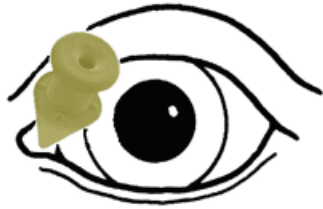

sizes: x-small, small, medium, large

- Insertion guides to facilitate introduction
- Micro beam(s) provides additional strength and integrity of the plug for insertion
- Visual size identification on each plug

Option #1 STERILE PRE-LOADED

Pre-loaded Pair + two Inserter Tools

24-2004 Pedi Plug 0.5mm

24-2005 x-small 0.6mm

24-2006 small 0.7mm

24-2007 medium 0.8mm

24-2008 large 0.9mm

Box contents:

- Two (2) plugs, pre-loaded
- Two (2) inserter tools
- Individually sterile
- Package in a rigid tray

STERILE

Option #2 NON-STERILE BULK

Plugs with one Inserter Tool

32-2004 Pedi plug 0.5mm

32-2005 x-small 0.6mm

32-2006 small 0.7mm

32-2007 medium 0.8mm

32-2008 large 0.9mm

Box contents:

- Twenty (20) plugs
- One (1) inserter tool

NON-STERILE



5385 Hollister Avenue, No. 216
Santa Barbara, CA 93111 U.S.A.

Telephone: 805 967-1153
FAX: 805 967-1295



Website: www.tecfe.com
email: tecfe@tecfe.com

Diagnostic Strips

Dry Eye Diagnostic Strips



2000 BioGlo™ Fluorescein Sodium Strips 100/box

2002 BioGlo™ Fluorescein Sodium Strips 300/box

2004 RoseGlo™, Rose Bengal Strips 100/box

2006 Lissamine Green Strips 100/box

2008 SoftGlo™, Sterile Large Molecule Fluorescein Strips 50/box

2010 TearFlo™, Sterile Tear Flow Test Strips 100/box

STERILE

CE



5385 Hollister Avenue, No. 216
Santa Barbara, CA 93111 U.S.A.

Telephone: 805 967-1153
FAX: 805 967-1295



Website: www.tecfe.com
email: tecfe@tecfe.com

Microkeratome Blades & Tubing System Compatible



TE-2200



TE-2300



TE-2400



TE-2410

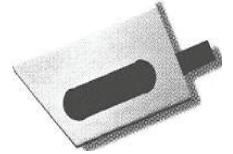

QE700

Microkeratome Blades, System Compatible

TE-2200	Chiron™ / Bausch & Lomb ACS™
TE-2300	Nidek™
TE-2400	Moria™ LSK-One™
TE-2410	Moria™ CB™
TE-2420/QE700	Moria™ M2™
QE100	Bausch & Lomb™ Hansatome™
QE101	Zyoptix™ XP™
QE400	SCMD™
QE700-90	Moria™ M2™ (Cuts 90 microns)



Keratome Tubing, System Compatible

Proper Keratome fittings with moisture trap
Disposable, STERILE, Precision filter captures moisture before damage caused to Microkeratome console.

QE101	Moria™ Keratome Tubing
QE102	Bausch & Lomb™



5385 Hollister Avenue, No. 216
Santa Barbara, CA 93111 U.S.A.

Telephone: 805 967-1153
FAX: 805 967-1295

Website: www.tecfe.com
email: tecfe@tecfe.com

PVA & Cellulose Sponge Eye Products

PVA

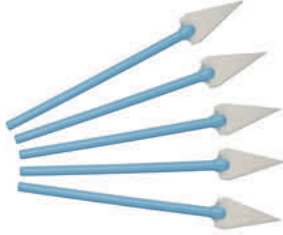

CELLULOSE

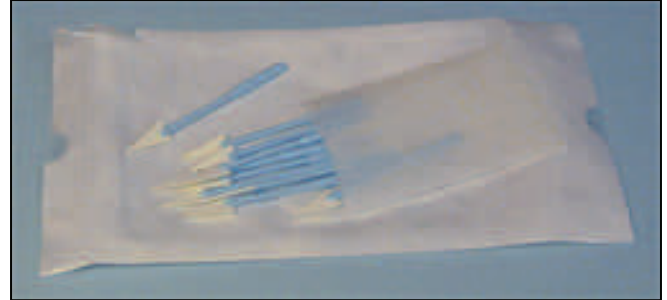

Specifically designed for LASIK & other delicate surgical procedures

PVA, Merocel, and Cellulose Eye Spears are STERILE, lint-free and highly absorbent

Also available in non-STERILE, bulk

Item No.	Description
TE-091A	PVA: 5 spears/foil ♦ 2 foils/tyvek ♦ 15 tyvek/box = 150 spears/box
TE-091BX	PVA: 5 spears/foil ♦ 30 foils/box = 150 spears/box
TE-091DX	PVA: 5 spears/foil ♦ 100 foils/bag = 500 spears/bag
705101	Merocel: 5 spears/foil ♦ 100 foils/bag = 500 spears/bag
TE-091K	PVA: 5 spears/foil ♦ 1000 foils/box = 5,000 spears/box
40405-8	PVA: 5 spears/foil ♦ 2 foils/pouch ♦ 20 pouches/box = 200 spears/box
40415	Cellulose: 10 spears/glassine ♦ 1 glassine/pack ♦ 20 packs/box = 200 spears/box



Lasik Disk

2/Pack, 20 Packs/Box

40804 UltraCell Lasik Disk w/Dark Blue Handle, 9mm diameter 2mm thickness

STERILE

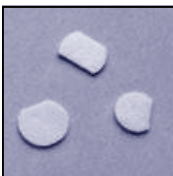

Lasik Shield

1/Pack, 20/Box

40820 7mm flat spot

40821 6mm flat spot

40822 4 and 8mm flat spot

STERILE



5385 Hollister Avenue, No. 216
Santa Barbara, CA 93111 U.S.A.

Telephone: 805 967-1153
FAX: 805 967-1295

Website: www.tecfe.com
email: tecfe@tecfe.com



Lasik Drain

1/Pack, 20/Box

40830 11.5mm opening 42mm x 17mm

40831 10.5mm opening 40mm x 14mm

STERILE



Corneal Light Shield

1/Pack 20/Box

400106 8mm

STERILE



Eye Drain & Wick

40430 Drain (80cc capacity), 1/Pack, 20/Box

40431 Wick (4mm x 170mm), 2/Pack, 10/Box

40435 Drain (400cc capacity), 1/Pack, 10/Box

STERILE

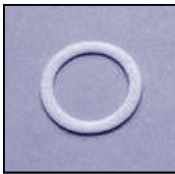

Bloomberg Ophthalmic Ring STERILE

40440 1.85cm,

1/Pack, 20/Box

STERILE

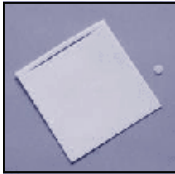

Eye Kit

1/Pack, 20/Box

40450 1 wipe/wick & 1 Light Shield (7mm)

STERILE



Cataract Kit 1/Pack, 20/Box

40451 5 Cell. Spears,

1 Corneal Light Shield (7mm),

1 Instrument Wipe (2mm),

1 Eye Drain (80cc)

STERILE

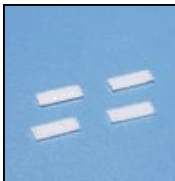

Eye Pledgets

10/Pack, 20/Box

40825 2mm x 6mm x 1mm thick

STERILE



Instrument WIPE

1/Pack, 20/Box

90910 7.6cm x 7.6 cm x 1mm

STERILE



Surgical Skin Marker with Ruler



1437SR-100



Sterile, Single Use Disposable Marking Pen

- Regular Tip
- Scrub resistant Gentian Violet Ink
- Sterile
- Packaged with 15 cm Ruler

STERILE

100 pieces/Case



5385 Hollister Avenue, No. 216
Santa Barbara, CA 93111 U.S.A.



Telephone: 805 967-1153
FAX: 805 967-1295



Website: www.tecfe.com
email: tecfe@tecfe.com

Transparent Dressing

TDS-24

6.0 cm x 7.0 cm, 100/box

TDS-26

10.0 cm x 12.0 cm, 50/box



Semi Permeable

STERILE



5860-C Hollister Avenue
Santa Barbara, CA 93117 U.S.A.



Telephone: 805 967-1153
FAX: 805 967-1295



Website: www.tecfe.com
email: tecfe@tecfe.com

Adhesive Skin Closure Strips



Skin Closure, Reinforced

751040pbx, 50/box	3 mm x 75 mm, (1/8" x 3")
751041pbx, 50/box	6 mm x 75 mm, (1/4" x 3")
751042pbx, 50/box	6 mm x 38 mm, (1/4" x 1 1/2")
751046pbx, 50/box	6 mm x 100 mm, (1/4" x 4")
751047pbx, 50/box	12 mm x 100 mm, (1/2" x 4")
751048pbx, 25/box	25 mm x 127 mm, (1" x 5")

STERILE



5860-C Hollister Avenue
Santa Barbara, CA 93117 U.S.A.



Telephone: 805 967-1153
FAX: 805 967-1295



Website: www.tecfe.com
email: tecfe@tecfe.com

Ophthalmic Surgery Drapes

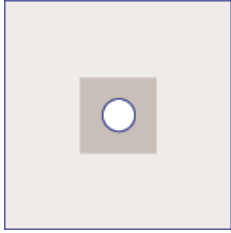

Aperture D1020

Size: 40cm x 40 cm

Aperture: 6 cm circle

Adhesive: 12 cm x 11 cm

USE: Cataract, corneal, refractive, lid/plastic, minor



Aperture D1030

Size: 83 cm x 129 cm

Aperture: 7 cm x 5 cm

Adhesive: 12 cm x 11 cm

USE: Cataract, vitreoretinal, corneal, lid/plastic

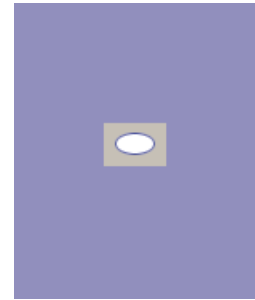

Aperture D2020

Size: 106 cm x 121 cm

Aperture: 7 cm x 5 cm

Adhesive: 12 cm x 11 cm

USE: Cataract, vitreoretinal, corneal

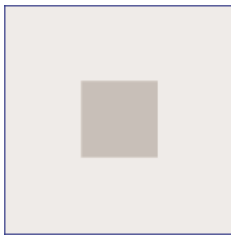

Incise D1021

Size: 40 cm x 40 cm

Aperture: 12 cm x 11 cm

USE: Cataract, refractive, vitreoretinal, corneal

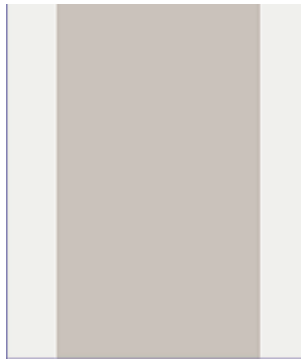

Incise D1035

Size: 16 cm x 19 cm

Adhesive: 10 cm x 19 cm

USE: Cataract, vitreoretinal, corneal, lid/plastic, minor

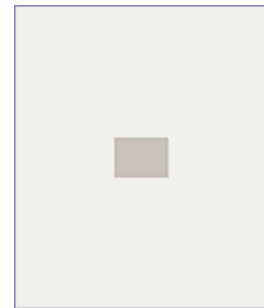

Incise D1060

Size: 121 cm x 129 cm

Adhesive: 12 cm x 11 cm

USE: Cataract, vitreoretinal, corneal

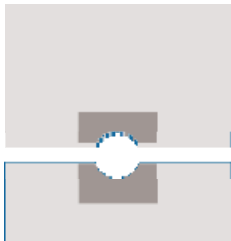

Refractive, Two Piece D1022

Size: 40 cm x 27 cm

Aperture: 3.8 cm x 2.5 cm

Adhesive: 7.6 cm x 7.6 cm

USE: Lasik, refractive, corneal, lid/plastic

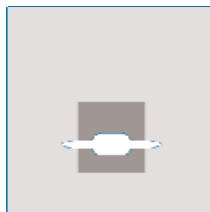

Refractive, One Piece D1122

Size: 40 cm x 27 cm

Aperture: 3.8 cm x 2.54 cm

Adhesive: 7.6 cm x 7.6 cm

USE: Lasik, refractive, corneal, lid/plastic



Lasik Eyelid Drape S-24

Size: 6 cm x 7 cm
100/box

USE: Lasik



5385 Hollister Avenue, No. 216
Santa Barbara, CA 93111 U.S.A.

Telephone: 805 967-1153
FAX: 805 967-1295

Website: www.tecfe.com
email: tecfe@tecfe.com

Ophthalmic Incise / Sheet Drapes

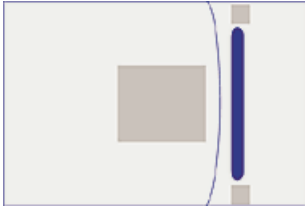

Incise Pouch

D1025 Size: 48 cm x 38 cm
Adhesive: 12 cm x 11 cm
(2) 2.5 cm x 5 cm TABS
USE: Cataract, vitreoretinal, corneal

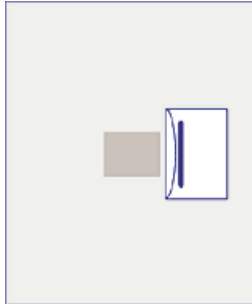

Incise Pouch

D1061 Size: 121 cm x 129 cm
Adhesive: 12 cm x 11 cm
USE: Cataract, vitreoretinal

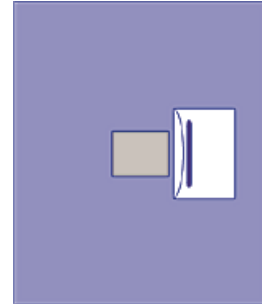

Incise Pouch

D1062 Size: 121 cm x 139 cm
Adhesive: 12 cm x 11 cm
USE: Cataract, vitreoretinal

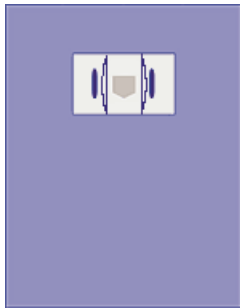

Incise Pouch

D1065 Size: 139 cm x 177 cm
D1165 Size: 139 cm x 292 cm
Adhesive: 11 cm x 12 cm
USE: Cataract, vitreoretinal

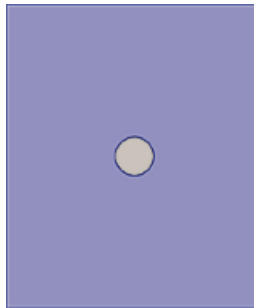

Incise Sheet

D2019 Size: 106 cm x 121 cm
Aperture: 7 cm circle
USE: Cataract, vitreoretinal, corneal

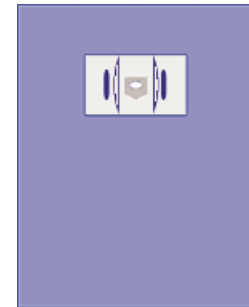

Aperture Sheet Pouch

D1064 Size: 139 cm x 177 cm
D1164 Size: 139 cm x 292 cm
Aperture: 5 cm x 3.8 cm
Adhesive: 11 cm x 12 cm
USE: Cataract, vitreoretinal



5385 Hollister Avenue, No. 216
Santa Barbara, CA 93111 U.S.A.

Telephone: 805 967-1153
FAX: 805 967-1295

Website: www.tecfe.com
email: tecfe@tecfe.com

Ophthalmic Pouch Drapes

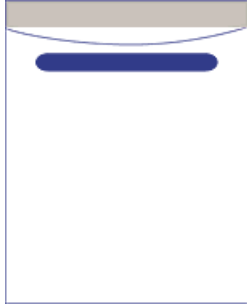

Irrigation Pouch

D2021 Size: 21 cm x 27 cm

Adhesive: 21 cm x 3.8 cm

USE: Cataract, vitreoretinal, corneal, ER, minor

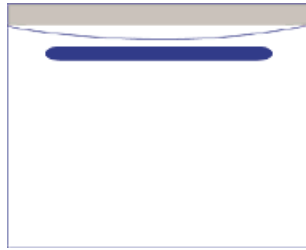

Irrigation Pouch

D2114 Size: 30 cm x 27 cm

Adhesive: 30 cm x 3.8 cm

USE: Cataract, vitreoretinal, corneal, ER, minor



Incise Sheet Pouch

D2258 Size: 129 cm x 190 cm

Adhesive: 12 cm x 11 cm

USE: Cataract, vitreoretinal, corneal

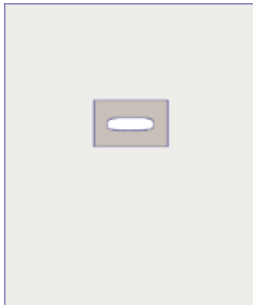

Strabismus

D2043 Size: 101 cm x 121 cm

Aperture: 13 cm x 3.8 cm

Adhesive: 30 cm x 3.8 cm

USE: Cataract, vitreoretinal, corneal, ER, minor

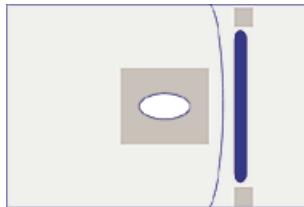

Aperture Pouch

D1024 Size: 48 cm x 38 cm

Aperture: 5 cm x 3 cm

Adhesive: 12 cm x 11 cm

USE: Cataract, vitreoretinal,

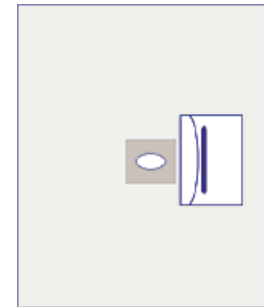

Aperture Pouch

D1031 Size: 121 cm x 129 cm

Aperture: 7 cm x 5 cm

Adhesive: 12 cm x 11 cm

USE: Cataract, vitreoretinal, corneal



5385 Hollister Avenue, No. 216
Santa Barbara, CA 93111 U.S.A.

Telephone: 805 967-1153
FAX: 805 967-1295

Website: www.tecfe.com
email: tecfe@tecfe.com

Ophthalmic Cannulas

Retrobulbar and Peribulbar Needles

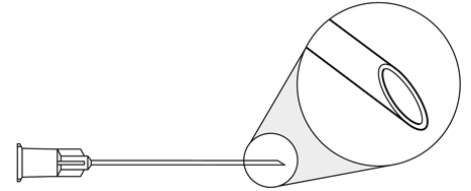
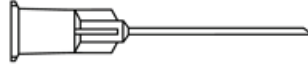

- | | |
|--|---|
| TE-0001C Peribulbar Needle [Atkinson] 27gX22mm [7/8"] | TE-0010 Retrobulbar Ndl. [Non Atkinson] 27gX38mm [1 1/2"] |
| TE-0001F Peribulbar Needle [Atkinson] 27gX32mm [1 1/4"] | TE-0011 Peribulbar Needle [Non Atkinson] 25gX25mm [1"] |
| TE-0001H Retrobulbar Needle [Atkinson] 27gX38mm [1 1/2"] | TE-0012 Peribulbar Needle [Non Atkinson] 25gX22mm [7/8"] |
| TE-0003A Peribulbar Needle [Atkinson] 25gX16mm [5/8"] | TE-0013 Peribulbar Needle [Non Atkinson] 23gX16mm [5/8"] |
| TE-0003C Peribulbar Needle [Atkinson] 25gX22mm [7/8"] | TE-0014 Peribulbar Needle [Non Atkinson] 25gX16mm [5/8"] |
| TE-0003F Peribulbar Needle [Atkinson] 25gX32mm [1 1/4"] | TE-0015 Peribulbar Needle [Non Atkinson] 27gX16mm [5/8"] |
| TE-0003H Retrobulbar Needle [Atkinson] 25gX38mm [1 1/2"] | TE-0016 Peribulbar Needle [Non Atkinson] 30gX16mm [5/8"] |
| TE-0004A Peribulbar Needle [Atkinson] 23gX16mm [5/8"] | TE-0020 Sub Tenon 19gX22mmX1" curved, flattened tip |
| TE-0004C Peribulbar Needle [Atkinson] 23gX22mm [7/8"] | TE-0021 Sub Tenon 21gX22mmX7/8" curved, tri port |
| TE-0004F Peribulbar Needle [Atkinson] 23gX32mm [1 1/4"] | TE-0022 Sub Tenon 21gX22mmX7/8" 7mm angled tip, tri port |
| TE-0004H Retrobulbar Needle [Atkinson] 23gX38mm [1 1/2"] | TE-0023 Sub Tenon 19gX25mmX1" curved, tri port |
| TE-0008 Retrobulbar Ndl. [Non Atkinson] 25gX38mm [1 1/2"] | TE-0024 Sub Tenon 19gX25mmX1" 7mm angled tip, tri port |
| TE-0009 Retrobulbar Ndl. [Non Atkinson] 26gX38mm [1 1/2"] | TE-0027S Rous 25gX16mm [5/8"] Extra Sharp curved, bevel down |

Anterior Chamber Cannulas

	3mm	4mm	5mm	6mm	7mm	8mm	9mm	10mm	11mm	12mm
30g	1000-3	*1000-4	1000-5	*1000-6	1000-7	1000-8	1000-9	1000-10	1000-11	1000-12
27g	1001-3	*1001-4	1001-5	*1001-6	1001-7	*1001-8	1001-9	1001-10	*1001-11	1001-12
25g	1003-3	1003-4	1003-5	*1003-6	1003-7	*1003-8	1003-9	1003-10	1003-11	1003-12
23g	1004-3	1004-4	1004-5	*1004-6	1004-7	*1004-8	1004-9	1004-10	1004-11	1004-12
21g	1006-3	1006-4	1006-5	1006-6	1006-7	1006-8	1006-9	1006-10	1006-11	1006-12
20g	1007-3	1007-4	1007-5	1007-6	1007-7	1007-8	1007-9	1007-10	1007-11	1007-12
19g	1008-3	1008-4	1008-5	1008-6	1008-7	1008-8	1008-9	1008-10	1008-11	1008-12

Anterior Chamber Cannulas (also known as: Air Injection, Rycroft, and Viscoelastic Cannulas) The most popular are marked with an "*". To use the chart, select the desired gauge and length of angled tip, then record that catalog number. (For example, a 27g cannula with a 6mm angled tip would be catalog number 1001-6). The drawings at the top of each column depict actual length of the angled tip.

Anterior Chamber Cannulas have the following specifications:

- angle - 32°
- length - 22mm (7/8") PLEASE NOTE: 19g
- tumble polished tips for smoother radii



5385 Hollister Avenue, No. 216
Santa Barbara, CA 93111 U.S.A.

Telephone: 805 967-1153
FAX: 805 967-1295

Website: www.tecfe.com
email: tecfe@tecfe.com

Anterior Chamber Cannulas

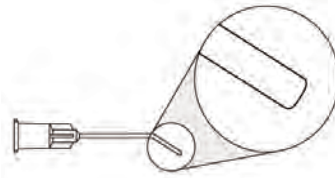

TE-1000-3	Anterior Chamber Cannulas 30g, 3mm bend	TE-1006-6	Anterior Chamber Cannulas 21g, 6mm bend
TE-1000-4	Anterior Chamber Cannulas 30g, 4mm bend	TE-1006-7	Anterior Chamber Cannulas 21g, 7mm bend
TE-1000-5	Anterior Chamber Cannulas 30g, 5mm bend	TE-1006-8	Anterior Chamber Cannulas 21g, 8mm bend
TE-1000-6	Anterior Chamber Cannulas 30g, 6mm bend	TE-1006-9	Anterior Chamber Cannulas 21g, 9mm bend
TE-1000-7	Anterior Chamber Cannulas 30g, 7mm bend	TE-1006-10	Anterior Chamber Cannulas 21g, 10mm bend
TE-1000-8	Anterior Chamber Cannulas 30g, 8mm bend	TE-1006-11	Anterior Chamber Cannulas 21g, 11mm bend
TE-1000-9	Anterior Chamber Cannulas 30g, 9mm bend	TE-1006-12	Anterior Chamber Cannulas 21g, 12mm bend
TE-1000-10	Anterior Chamber Cannulas 30g, 10mm bend	TE-1007-3	Anterior Chamber Cannulas 20g, 3mm bend
TE-1000-11	Anterior Chamber Cannulas 30g, 11mm bend	TE-1007-4	Anterior Chamber Cannulas 20g, 4mm bend
TE-1000-12	Anterior Chamber Cannulas 30g, 12mm bend	TE-1007-5	Anterior Chamber Cannulas 20g, 5mm bend
TE-1001-3	Anterior Chamber Cannulas 27g, 3mm bend	TE-1007-6	Anterior Chamber Cannulas 20g, 6mm bend
TE-1001-4	Anterior Chamber Cannulas 27g, 4mm bend	TE-1007-7	Anterior Chamber Cannulas 20g, 7mm bend
TE-1001-5	Anterior Chamber Cannulas 27g, 5mm bend	TE-1007-8	Anterior Chamber Cannulas 20g, 8mm bend
TE-1001-6	Anterior Chamber Cannulas 27g, 6mm bend	TE-1007-9	Anterior Chamber Cannulas 20g, 9mm bend
TE-1001-7	Anterior Chamber Cannulas 27g, 7mm bend	TE-1007-10	Anterior Chamber Cannulas 20g, 10mm bend
TE-1001-8	Anterior Chamber Cannulas 27g, 8mm bend	TE-1007-11	Anterior Chamber Cannulas 20g, 11mm bend
TE-1001-9	Anterior Chamber Cannulas 27g, 9mm bend	TE-1007-12	Anterior Chamber Cannulas 20g, 12mm bend
TE-1001-10	Anterior Chamber Cannulas 27g, 10mm bend	TE-1008-3	Anterior Chamber Cannulas 19g, 3mm bend
TE-1001-11	Anterior Chamber Cannulas 27g, 11mm bend	TE-1008-4	Anterior Chamber Cannulas 19g, 4mm bend
TE-1001-12	Anterior Chamber Cannulas 27g, 12mm bend	TE-1008-5	Anterior Chamber Cannulas 19g, 5mm bend
TE-1003-3	Anterior Chamber Cannulas 25g, 3mm bend	TE-1008-6	Anterior Chamber Cannulas 19g, 6mm bend
TE-1003-4	Anterior Chamber Cannulas 25g, 4mm bend	TE-1008-7	Anterior Chamber Cannulas 19g, 7mm bend
TE-1003-5	Anterior Chamber Cannulas 25g, 5mm bend	TE-1008-8	Anterior Chamber Cannulas 19g, 8mm bend
TE-1003-6	Anterior Chamber Cannulas 25g, 6mm bend	TE-1008-9	Anterior Chamber Cannulas 19g, 9mm bend
TE-1003-7	Anterior Chamber Cannulas 25g, 7mm bend	TE-1008-10	Anterior Chamber Cannulas 19g, 10mm bend
TE-1003-8	Anterior Chamber Cannulas 25g, 8mm bend	TE-1008-11	Anterior Chamber Cannulas 19g, 11mm bend
TE-1003-9	Anterior Chamber Cannulas 25g, 9mm bend	TE-1008-12	Anterior Chamber Cannulas 19g, 12mm bend
TE-1003-10	Anterior Chamber Cannulas 25g, 10mm bend	TE-1100S	Anterior Chamber Cannulas 30gX22mm(7/8"),straight
TE-1003-11	Anterior Chamber Cannulas 25g, 11mm bend	TE-1100C	Anterior Chamber Cannulas 30gX22mm(7/8"),curved
TE-1003-12	Anterior Chamber Cannulas 25g, 12mm bend	TE-1101S	Anterior Chamber Cannulas 27gX22mm(7/8"), straight
TE-1004-3	Anterior Chamber Cannulas 23g, 3mm bend	TE-1101C	Anterior Chamber Cannulas 27gX22mm(7/8"), curved
TE-1004-4	Anterior Chamber Cannulas 23g, 4mm bend	TE-1103S	Anterior Chamber Cannulas 25gX22mm(7/8"), straight
TE-1004-5	Anterior Chamber Cannulas 23g, 5mm bend	TE-1103C	Anterior Chamber Cannulas 25gX22mm(7/8"), curved
TE-1004-6	Anterior Chamber Cannulas 23g, 6mm bend	TE-1104S	Anterior Chamber Cannulas 23gX22mm(7/8"), straight
TE-1004-7	Anterior Chamber Cannulas 23g, 7mm bend	TE-1104SL	Anterior Chamber Cannulas 23gX32mm(1 1/4"), straight
TE-1004-8	Anterior Chamber Cannulas 23g, 8mm bend	TE-1104C	Anterior Chamber Cannulas 23gX22mm(7/8"), curved
TE-1004-9	Anterior Chamber Cannulas 23g, 9mm bend	TE-1106S	Anterior Chamber Cannulas 21gX22mm(7/8"), straight
TE-1004-10	Anterior Chamber Cannulas 23g, 10mm bend	TE-1106C	Anterior Chamber Cannulas 21gX22mm(7/8"), curved
TE-1004-11	Anterior Chamber Cannulas 23g, 11mm bend	TE-1107S	Anterior Chamber Cannulas 20gX25mm(1"), straight
TE-1004-12	Anterior Chamber Cannulas 23g, 12mm bend	TE-1107C	Anterior Chamber Cannulas 20gX25mm(1"), curved
TE-1006-3	Anterior Chamber Cannulas 21g, 3mm bend	TE-1108S	Anterior Chamber Cannulas 19gX25mm(1"), straight
TE-1006-4	Anterior Chamber Cannulas 21g, 4mm bend	TE-1108C	Anterior Chamber Cannulas 19gX25mm(1"), curved
TE-1006-5	Anterior Chamber Cannulas 21g, 5mm bend	TE-1200	Viscoelastic Cannula 27gX22mm(7/8"), formed













5385 Hollister Avenue, No. 216
Santa Barbara, CA 93111 U.S.A.

Telephone: 805 967-1153
FAX: 805 967-1295

Website: www.tecfe.com
email: tecfe@tecfe.com

Anterior Chamber Cannulas, Thin Wall

	3mm	4mm	5mm	6mm	7mm	8mm	9mm	10mm	11mm	12mm
										
25gTW	2003-3	2003-4	2003-5	*2003-6	2003-7	*2003-8	2003-9	2003-10	2003-11	2003-12
23gTW	2004-3	2004-4	2004-5	*2004-6	2004-7	*2004-8	2004-9	2004-10	2004-11	2004-12

* Denotes most requested Thin Wall Anterior Chamber Cannulas.

Thin Wall Anterior Chamber Cannulas (also known as: Air Injection, Rycroft, and Viscoelastic Cannulas)

The most popular have been marked with an "*". To use the chart, select the desired gauge and length of angled tip, then record that catalog number. (For example, a 25g thin wall cannula with a 6mm angled tip would be catalog number 2003-6). The drawings at the top of each column depict actual length of the angled tip.

Thin Wall Anterior Chamber Cannulas have the following specifications:

- angle - 32°
- length - 22mm (7/8")
- tumble polished tips for smoother radii

Thin Wall

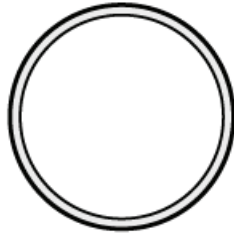

Regular Wall

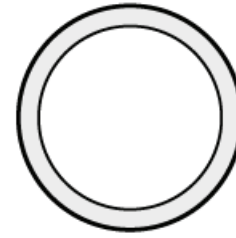

1. Advantages to Thin Wall Cannulas:

The inside diameter is approximately 2 gauge sizes larger, therefore a 25g T.W. lumen is approximately the same as the inside lumen on a 23g (see illustration).

- Viscous materials flow through the cannulas with less effort.
- Thin Wall Cannulas allow the advantages of a larger bore through a smaller cannula.

TE-2003-3 Anterior Chamber Cannulas TW 25g, 3mm bend
TE-2003-4 Anterior Chamber Cannulas TW 25g, 4mm bend
TE-2003-5 Anterior Chamber Cannulas TW 25g, 5mm bend
TE-2003-6 Anterior Chamber Cannulas TW 25g, 6mm bend
TE-2003-7 Anterior Chamber Cannulas TW 25g, 7mm bend
TE-2003-8 Anterior Chamber Cannulas TW 25g, 8mm bend
TE-2003-9 Anterior Chamber Cannulas TW 25g, 9mm bend
TE-2003-10 Anterior Chamber Cannulas TW 25g, 10mm bend
TE-2003-11 Anterior Chamber Cannulas TW 25g, 11mm bend
TE-2003-12 Anterior Chamber Cannulas TW 25g, 12mm bend
TE-2004-3 Anterior Chamber Cannulas TW 23g, 3mm bend
TE-2004-4 Anterior Chamber Cannulas TW 23g, 4mm bend

TE-2004-5 Anterior Chamber Cannulas TW 23g, 5mm bend
TE-2004-6 Anterior Chamber Cannulas TW 23g, 6mm bend
TE-2004-7 Anterior Chamber Cannulas TW 23g, 7mm bend
TE-2004-8 Anterior Chamber Cannulas TW 23g, 8mm bend
TE-2004-9 Anterior Chamber Cannulas TW 23g, 9mm bend
TE-2004-10 Anterior Chamber Cannulas TW 23g, 10mm bend
TE-2004-11 Anterior Chamber Cannulas TW 23g, 11mm bend
TE-2004-12 Anterior Chamber Cannulas TW 23g, 12mm bend
TE-2103S Anterior Chamber Cannulas TW 25g, straight
TE-2103C Anterior Chamber Cannulas TW 25g, curved
TE-2104S Anterior Chamber Cannulas TW 23g, straight
TE-2104C Anterior Chamber Cannulas TW 23g, curved



5385 Hollister Avenue, No. 216
 Santa Barbara, CA 93111 U.S.A.

Telephone: 805 967-1153
 FAX: 805 967-1295

Website: www.tecfe.com
 email: tecfe@tecfe.com

I/A Cannulas and Cortex Removal

TE-3000	Dbl. I/A Cann. 21gX21g, side port
TE-3000J	"J" Shaped Dbl. I/A Cann. 23gX25gX1 1/2"
TE-3001	Dbl. I/A Cann. 21gX21g, open end
TE-3002	Dbl. I/A Cann. 21gX19g, open end
TE-3003	Dbl. Barrel Cann. [Simcoe] 23gX23g
TE-3003R	Dbl. Barrel Cann. [Simcoe] 23gX23g reusable
TE-3004	Rvrs. Dbl. Barrel Cann. [Simcoe] 23gX23g
TE-3005	Cortex Extractor [Simcoe] 23gX13mm
TE-3006	Cortex Extractor [Simcoe] 23gX22mm
TE-3007	Crtx. Extractor [Charleux] 23gX1/2", curved

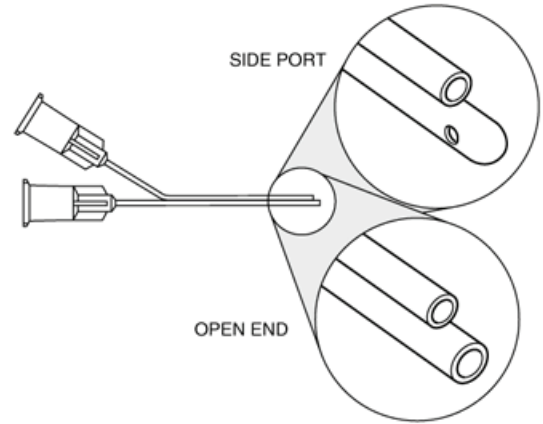

J Shaped Cannulas

TE-4000	"J" Shape Cannula 30g
TE-4001	"J" Shape Cannula 27g
TE-4003	"J" Shape Cannula 25g
TE-4003C	Viscoexpression Cannula [Corydon] 25g
TE-4003-10	"J" Shape Cannula 25gX10mm bend
TE-4003-17L	[Binkhorst] Cannula 25g, left
TE-4003-17R	[Binkhorst] Cannula 25g, right
TE-4003M	Micro "J" Shaped Cannula [Hessburg] 25g
TE-4004	"J" Shape Cannula 23g
TE-4004-10	"J" Shape Cannula 23gX10mm bend
TE-4006	"J" Shape Cannula 21g

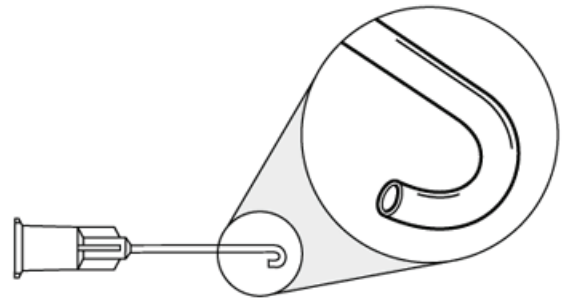

Irrigating Cystotomes

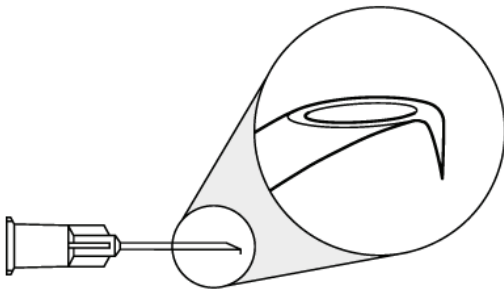

TE-5000AS	Irrigating Cystotome 30gX16mm(5/8"), straight
TE-5001AS	Irrigating Cystotome 27gX16mm(5/8"), straight
TE-5001BS	Irrigating Cystotome 27gX19mm(3/4"), straight
TE-5003AS	Irrigating Cystotome 25gX16mm(5/8"), straight
TE-5003CS	Irrigating Cystotome 25gX22mm(7/8"), straight
TE-5004AS	Irrigating Cystotome 23gX16mm(5/8"), straight
TE-5004BS	Irrigating Cystotome 23gX19mm(3/4"), straight
TE-5000AF	Irrigating Cystotome 30gX16mm(5/8"), formed
TE-5001AF	Irrigating Cystotome 27gX16mm(5/8"), formed
TE-5001BF	Irrigating Cystotome 27gX19mm(3/4"), formed
TE-5003AF	Irrigating Cystotome 25gX16mm(5/8"), formed
TE-5003CF	Irrigating Cystotome 25gX22mm(7/8"), formed
TE-5004AF	Irrigating Cystotome 23gX16mm(5/8"), formed
TE-5004BF	Irrigating Cystotome 23gX19mm(3/4"), formed
TE-5001AA	Irrigating Cystotome 27gX16mm(5/8"), angled
TE-5003AA	Irrigating Cystotome 25gX16mm(5/8"), angled
TE-5001AC	Irrigating Cystotome [Joyce] 27gX16mm(5/8"), curved
TE-5003AC	Irrigating Cystotome [Joyce] 25gX16mm(5/8"), curved
TE-5003ASC	Irrigating Cystotome 25gX16mm(5/8"), side cut
TE-5001ASR	Irrigating Cystotome 27gX16mm(5/8"), small radius
TE-5003ASR	Irrigating Cystotome 25gX16mm(5/8"), small radius
TE-5003ARF	Irrigating Cystotome 25gX16mm(5/8"), reverse formed



5385 Hollister Avenue, No. 216
Santa Barbara, CA 93111 U.S.A.

Telephone: 805 967-1153
FAX: 805 967-1295

Website: www.tecfe.com
email: tecfe@tecfe.com

Irrigating Cystotomes

- TE-5007** Capsulorhexis Cystotome 27g
- TE-5007S** Capsulorhexis Cystotome 27g, straight
- TE-5008** Capsulorhexis Cystotome 25g
- TE-5008S** Capsulorhexis Cystotome 25g, straight
- TE-5009** Capsulorhexis Cystotome 23g
- TE-5009S** Capsulorhexis Cystotome 23g, straight
- TE-5010** Irrigating Sharp Cystotome 22g
- TE-5011** Irrigating Double Sharp Cyst. 22g

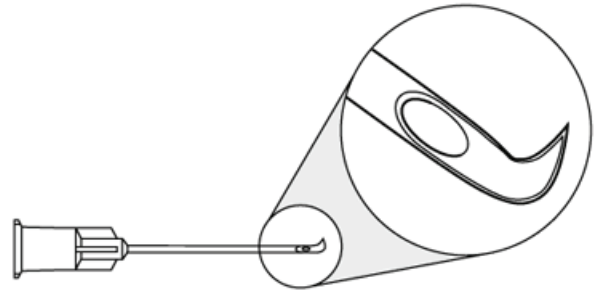

Capsule Polishers

- TE-6000** Capsule Polisher 21g, sideport
- TE-6001** Capsule Polisher 23g, sideport
- TE-6002** Capsule Polisher 21g, open end
- TE-6003** Capsule Polisher 23g, open end
- TE-6005** Posterior Capsule Polisher 23g
- TE-6006** Flex. Tip Cap. Pol. 23gX7mm bend
- TE-6007** Flex. Tip Cap. Pol. 27gX7mm bend
- TE-6008** Flex. Tip Cap. Pol. 23gX9mm bend

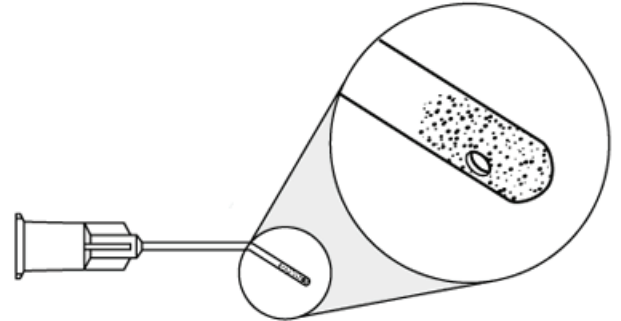

Nucleus Removal, Irrigating, Hydrodissection and Hydrodelineation

- TE-7000** Irrigating Vectis 25g, 1 port
- TE-7001** Irrigating Vectis 25g, 1 port, 3mm
- TE-7002** Irrigating Vectis 25g, 2 port, 4mm
- TE-7003** Irrigating Vectis 25g, 3 port
- TE-7004** Anterior Washout Cannula 19g
- TE-7005** Hydrodissection Cannula 30g
- TE-7006** Hydrodissection Cannula 27g
- TE-7007** Hydrodissection Cannula 25g
- TE-7008** Hydrodissection Cannula 23g
- TE-7009A** "J" Shape Hydrodisc. Cannula 30g
- TE-7009B** "J" Shape Hydrodisc. Cannula 27g
- TE-7009C** "J" Shape Hydrodisc. Cannula 25g
- TE-7010** Hydrodelin. Ndl.[Kellan] 25g
- TE-7011** Hydrodelin. Ndl.[Kellan] 27g
- TE-7012** Hydrodelin. Ndl.[Kellan] 25g, curved
- TE-7013** Hydrodelin. Ndl.[Kellan] 27g, curved
- TE-7014** Nuc. Hydrolysis Ndl.[P. Koch] 25g, curved
- TE-7015** Nuc. Hydrodissector / Rotator [Sinskey] 25g.
- TE-7016** Cortical Cleaving Hydrodissector 27g
- TE-7017** Nucleus Hydrodissector 27g, curved
- TE-7018** Chang Hydrodissection Cannula 27g

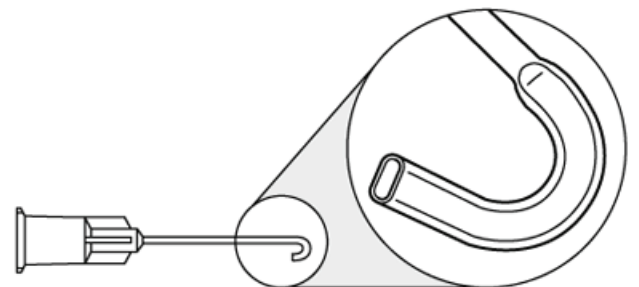
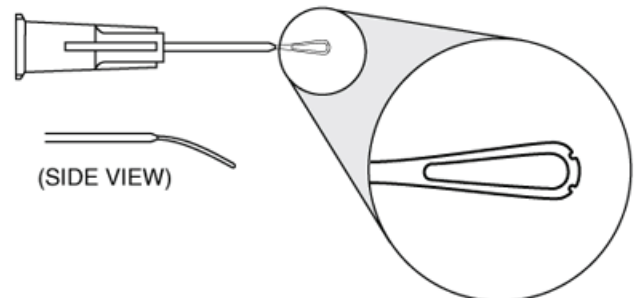

Lacrimal Products and Miscellaneous Instruments

- TE-8000 Lacrimal Cannula 25g, curved
- TE-8000-26 Lacrimal Cannula 26g, curved
- TE-8000S Lacrimal Cann. 19g, tapered to 23g, straight
- TE-8001 Lacrimal Intubation Set
- TE-8002 Lac. Intb. Set w/retriever
- TE-8002WO Lac. Intb. Set no/retriever
- TE-8003S DCR Set, straight
- TE-8003A DCR Set, angled
- TE-8200S Micro Lens Hook [Sinsky] II str.
- TE-8200A Micro Lens Hook [Sinsky] II ang.
- TE-8201 Lens Manipulating Hook [Fenz]
- TE-8202 Button Tip Manipulator, angled
- TE-8203 Lens Manipulator [Jaffe-Maltzman], ang.
- TE-8204 IOL Manipulating Hook [Lester], ang.
- TE-8205 Nucleus Rotator [Jaffe-Bechert], ang.
- TE-8206 Micro Iris Retractor [Pearce] angled
- TE-8207 Irrigating Dialer
- TE-8208 Nucleus Spatula [Pearce]
- TE-8209 Nucleus Chopper, angled
- TE-8400 Eye Speculum [Barraquer] adult
- TE-8401 Eye Speculum [Barraquer] child
- TE-8402 Eye Speculum [Kratz] adult
- TE-8500 Alpha-chymotrypsin
- TE-8500S Olive Tip Capsule Polisher 25g, curved
- TE-8501 Olive Tip Cannula 23gX7/8", curved
- TE-8501S Olive Tip Capsule Polisher 23g, curved
- TE-8503 Olive Tip Capsule Polisher 23g, angled
- TE-8600 Infusion Handle
- TE-8601 Male to Female Handpiece
- TE-8602 Double Male Handpiece
- TE-8603 Aspirating Handpiece w/finger hole

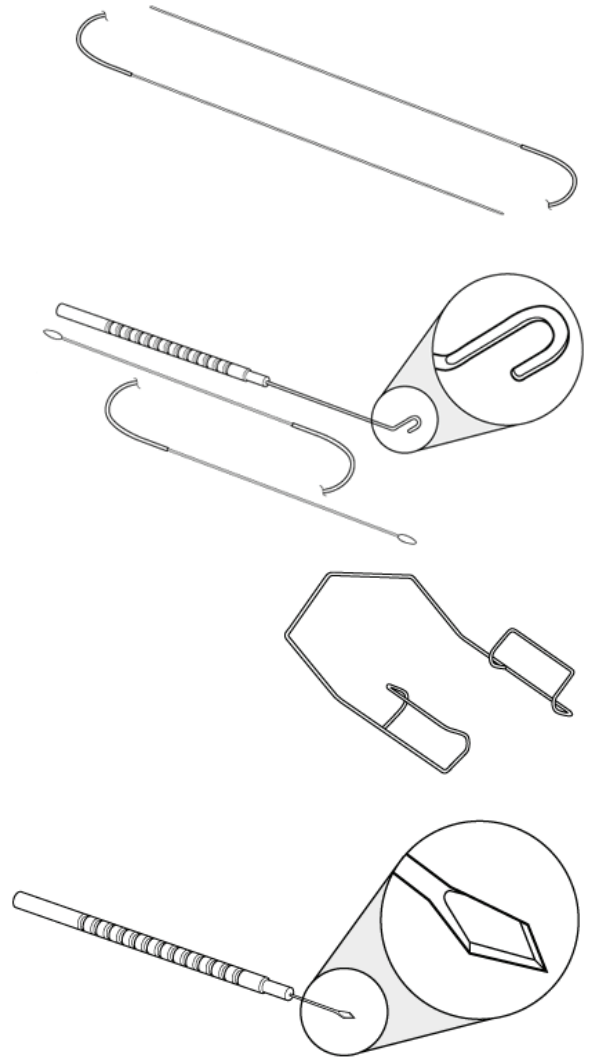

Chamber Maintainers and Retinal Cannulas

- TE-9000 Chamber Maintainer 27g
- TE-9001 Chamber Maintainer 25g
- TE-9002 Chamber Maintainer 23g
- TE-9003 Chamber Maintainer 20g
- TE-9004 Chmb. Maint. w/serrated tip 25g
- TE-9005 Chmb. Maint. w/serrated tip 23g
- TE-9006 Chmb. Maint. w/serrated tip 20g
- TE-9007 Infusion Cannula 20g, 2.5mm tip
- TE-9008 Infusion Cannula 20g, 4mm tip
- TE-9009 Infusion Cannula 20g, 6mm tip

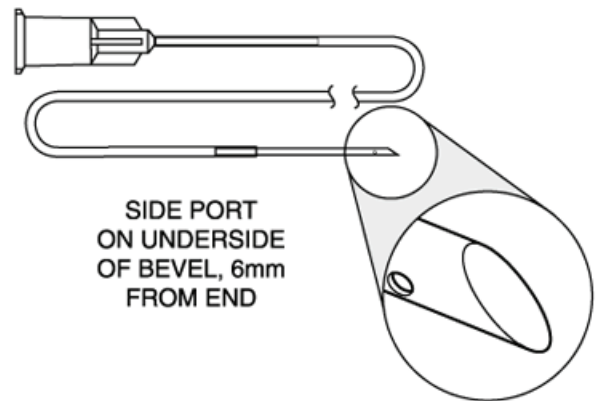

5385 Hollister Avenue, No. 216
Santa Barbara, CA 93111 U.S.A.

Telephone: 805 967-1153
FAX: 805 967-1295

Website: www.tecfe.com
email: tecfe@tecfe.com

Chamber Maintainers and Retinal Cannulas

- TE-9010SB** Extru. Cann. 20g, straight, blunt
- TE-9010ST** Extru. Cann. 20g, straight, tapered
- TE-9010STS** Extru. Cann. w/sil.tub.20g,str., tprd
- TE-9010AT** Extru. Cann. 20g, angled, tapered
- TE-9010ATS** Extru. Cann. w/sil.tub.20g,ang., tprd
- TE-9011SB** Extru. Cann. 19g, straight, blunt
- TE-9011ST** Extru. Cann. 19g, straight, tapered
- TE-9011STS** Extru. Cann. w/sil.tub.19g,str., tprd
- TE-9011AT** Extru. Cann. 19g, angled, tapered
- TE-9011ATS** Extru. Cann. w/sil.tub.19g,ang., tprd
- TE-9012SB** Extru. Cann. 23g, straight, blunt
- TE-9020** High Viscosity Fluid Needle 16g
- TE-9021** Mem. Diss. [Kingham] 20gX25mm
- TE-9022** Subretinal Injector [Lambert] 20g. tapered
- TE-9023** Subretinal Injector [Landers] 20g. tapered
- TE-9025** Flute Needle [Charles] 19gX1"
- TE-9029** Membrane Mircopick [Eaton] 20g, tapered
- TE-9030** Vitreoretinal Micropick 20g, tapered
- TE-9031** Vitreoretinal Micropick 23g, tapered
- TE-9032** Vitreoretinal Cann. [Vander] 20g, tprd., strt.
- TE-9032A** Vitreoretinal Cann. [Vander] 20g, tprd., angl.
- TE-9033** Subretinal Injector [Glaser] 20g, tapered, curved
- TE-9034** Subretinal Injector [Glaser] 20g, tapered, straight
- TE-9035** MVR Cannula [Glaser] 20g, tapered angled
- TE-9036** Subretinal Cannula [Lambert] 20g, tapered, curved

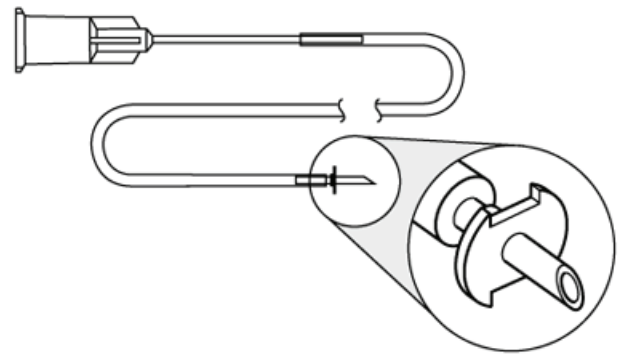
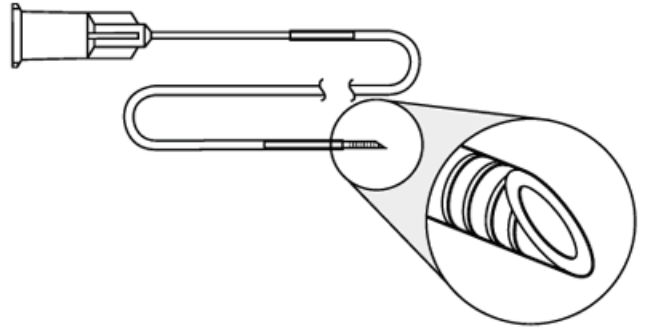

Lasik Cannulas

- TE-9901D** [Dishler] Lasik Cannula 27g.
- TE-9902S** [Slade] Lasik Cannula 26g.
- TE-9903-8T** Newman Combo Lasik Cannula 25g.
- TE-9903-9** Linn Lasik Cannula 25g.
- TE-9903B** Gulani Triple Function Lasik Cannula 16g, tprd.

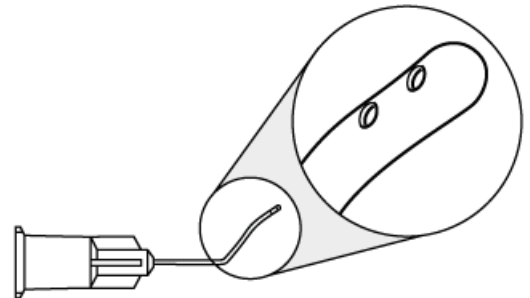

5385 Hollister Avenue, No. 216
Santa Barbara, CA 93111 U.S.A.

Telephone: 805 967-1153
FAX: 805 967-1295

Website: www.tecfe.com
email: tecfe@tecfe.com

Ophthalmic Knives & Blades

DEGREE KNIVES & BLADES - ROUND, 6/box

TE-961502	15 DEGREE COLLET
TE-961501	15 DEGREE KNIFE
TE-921531	15 DEGREE KNIFE ANGLED LEFT
TE-921541	15 DEGREE KNIFE ANGLED RIGHT
TE-922202	22.5 DEGREE COLLET
TE-922201	22.5 DEGREE KNIFE
TE-923002	30 DEGREE COLLET
TE-923001	30 DEGREE KNIFE
TE-924502	45 DEGREE COLLET
TE-924501	45 DEGREE KNIFE

CRESCENT/SPOON - ROUND STOCK, 6/box

TE-940001	CRESCENT KNIFE STRAIGHT
TE-940002	CRESCENT KNIFE ANGLED BEVEL UP
TE-940003	CRESCENT KNIFE ANGLED BEVEL DOWN
TE-940006	CRESCENT KNIFE ANGLED DOUBLE BEVEL
TE-960011	CRESCENT COLLET STRAIGHT
TE-960012	CRESCENT COLLET ANGLED BEVEL UP
TE-960021	CRESCENT 2.0MM KNIFE STRAIGHT
TE-960022	CRESCENT 2.0MM KNIFE ANGLED BEVEL UP
TE-942268*	SYMMETRY SPOON 2.25MM ANGLED
TE-942568	SYMMETRY SPOON 2.5MM ANGLED
TE-943068*	SYMMETRY SPOON 3.0MM ANGLED

CRESCENT/SPOON/TUNNEL - FLAT STOCK, 6/box

TE-6828*	CRESCENT KNIFE ANGLED BEVEL DOWN
TE-6825*	SPOON 2.5MM BLADE ANGLED
TE-6825H*	SPOON 2.5MM BEVEL UP KNIFE ANGLED
TE-6821H*	SPOON MEDIUM 3.0MM KNIFE ANGLED
TE-4805	TUNNEL II BLADE ANGLED BEVEL UP
TE-4806*	TUNNEL II BLADE STRAIGHT
TE-4807	TUNNEL II KNIFE ANGLED BEVEL UP
TE-4808*	TUNNEL II KNIFE STRAIGHT

SLIT KNIVES AND BLADES - ROUND STOCK, 6/box

TE-962211	SLIT 2.2 MM KNIFE STRAIGHT
TE-962261	SLIT 2.2 MM KNIFE ANGLED
TE-962301	SLIT 2.3 MM KNIFE STRAIGHT
TE-962361	SLIT 2.3MM KNIFE ANGLED
TE-962501	SLIT 2.5MM KNIFE STRAIGHT
TE-962561	SLIT 2.5MM KNIFE ANGLED
TE-962601	SLIT 2.65MM KNIFE STRAIGHT
TE-962661	SLIT 2.65MM KNIFE ANGLED
TE-962751	SLIT 2.75MM KNIFE ANGLED
TE-962711	SLIT 2.75MM KNIFE STRAIGHT

DEGREE KNIVES & BLADES - FLAT, 6/box

TE-7511	15 DEGREE COLLET 1.5MM DEPTH
TE-7512	15 DEGREE KNIFE 1.5MM DEPTH
TE-7513	15 DEGREE COLLET 3.0MM DEPTH
TE-7514	15 DEGREE KNIFE 3.0MM DEPTH
TE-7515	15 DEGREE COLLET 5.0MM DEPTH
TE-7516	15 DEGREE KNIFE 5.0MM DEPTH
TE-7517	15 DEGREE COLLET 7.0MM DEPTH
TE-7518	15 DEGREE KNIFE 7.0MM DEPTH
TE-7522	22.5 DEGREE COLLET 4.0MM DEPTH
TE-7523	22.5 DEGREE KNIFE 4.0MM DEPTH
TE-7530	30 DEGREE COLLET 3.5MM DEPTH
TE-7531	30 DEGREE KNIFE 3.5MM DEPTH
TE-7535	30 DEGREE COLLET 5.0MM DEPTH
TE-7536	30 DEGREE KNIFE 5.0MM DEPTH
TE-7545	45 DEGREE COLLET 3.0MM DEPTH
TE-7546	45 DEGREE KNIFE 3.0MM DEPTH
TE-7550	45 DEGREE COLLET 5.0MM DEPTH
TE-7551	45 DEGREE KNIFE 5.0MM DEPTH

TRAPEZOID SLIT KNIVES - ROUND STOCK, 6/box

TE-971214	TRAPEZOID SLIT KNIFE 1.2 x 1.4MM ANGLED
TE-971416	TRAPEZOID SLIT KNIFE 1.4 x 1.6MM ANGLED
TE-971520	TRAPEZOID SLIT KNIFE 1.5 x 2.0MM ANGLED
TE-972832	TRAPEZOID SLIT KNIFE 2.8 x 3.2MM ANGLED

MICRO INCISION SLIT - ROUND STOCK, 6/box

TE-961161	SLIT 1.1 MM KNIFE ANGLED
TE-961361	SLIT 1.3 MM KNIFE ANGLED
TE-961561	SLIT 1.5 MM KNIFE ANGLED
TE-961761	SLIT 1.75 MM KNIFE ANGLED
TE-961861	SLIT 1.8 MM KNIFE ANGLED
TE-962161	SLIT 2.0 MM KNIFE ANGLED

**ITEMS MARKED WITH *
REQUIRE MINIMUM ORDER
AND 4-6 WEEK DELIVERY**



5385 Hollister Avenue, No. 216
Santa Barbara, CA 93111 U.S.A.

Telephone: 805 967-1153
FAX: 805 967-1295

Website: www.tecfe.com
email: tecfe@tecfe.com

SLIT KNIVES AND BLADES - ROUND STOCK, 6/box

TE-962801	SLIT 2.8MM KNIFE STRAIGHT
TE-962861	SLIT 2.8MM KNIFE ANGLED
TE-962811	SLIT 2.85MM KNIFE STRAIGHT
TE-962851	SLIT 2.85MM KNIFE ANGLED
TE-962901	SLIT 3.0MM KNIFE STRAIGHT
TE-962961	SLIT 3.0MM KNIFE ANGLED
TE-963201	SLIT 3.2MM KNIFE STRAIGHT
TE-963261	SLIT 3.2MM KNIFE ANGLED
TE-933262	SLIT 3.2MM COLLET ANGLED
TE-963501	SLIT 3.5MM KNIFE STRAIGHT
TE-963561	SLIT 3.5MM KNIFE ANGLED
TE-965001	SLIT 5.1MM KNIFE STRAIGHT
TE-965061	SLIT 5.1MM KNIFE ANGLED
TE-962568	SYMMETRY SLIT 2.5MM KNIFE ANGLED
TE-962608	SYMMETRY SLIT 2.65MM KNIFE STRAIGHT
TE-962668	SYMMETRY SLIT 2.65MM KNIFE ANGLED
TE-962808	SYMMETRY SLIT 2.8MM KNIFE STRAIGHT
TE-962868	SYMMETRY SLIT 2.8MM KNIFE ANGLED
TE-962908	SYMMETRY SLIT 3.0MM KNIFE STRAIGHT
TE-962968	SYMMETRY SLIT 3.0MM KNIFE ANGLED
TE-963208	SYMMETRY SLIT 3.2MM KNIFE STRAIGHT
TE-963268	SYMMETRY SLIT 3.2MM KNIFE ANGLED
TE-963568	SYMMETRY SLIT 3.5MM KNIFE ANGLED

SLIT KNIVES AND BLADES - FLAT STOCK. 6/box

TE-5504	SLIT 1.5MM SLIT BLADE ANGLED
TE-5541*	SLIT 2.65MM KNIFE STRAIGHT
TE-5516	SLIT 2.8MM BLADE ANGLED
TE-5517*	SLIT 2.8MM BLADE STRAIGHT
TE-4740	SLIT 2.8MM KNIFE ANGLED
TE-4741*	SLIT 2.8MM KNIFE STRAIGHT
TE-5520	SLIT 3.0MM BLADE ANGLED
TE-5520BU	SLIT 3.0MM BLADE ANGLED BEVEL UP
TE-5521	SLIT 3.0MM BLADE STRAIGHT
TE-5570	SLIT 3.0MM KNIFE ANGLED
TE-5570BU	SLIT 3.0MM KNIFE ANGLED BEVEL UP
TE-5571*	SLIT 3.0MM KNIFE STRAIGHT
TE-5522	SLIT 3.2MM BLADE ANGLED
TE-5522BU	SLIT 3.2MM BLADE ANGLED BEVEL UP
TE-5572*	SLIT 3.2MM KNIFE ANGLED
TE-5572BU	SLIT 3.2MM KNIFE ANGLED BEVEL UP
TE-5530	SLIT 3.5MM BLADE ANGLED
TE-5530BU	SLIT 3.5MM BLADE ANGLED BEVEL UP
TE-5580	SLIT 3.5MM KNIFE ANGLED
TE-5580BU	SLIT 3.5MM KNIFE ANGLED BEVEL UP

**ITEMS MARKED WITH *
REQUIRE MINIMUM ORDER
AND 4-6 WEEK DELIVERY**



5385 Hollister Avenue, No. 216
Santa Barbara, CA 93111 U.S.A.

Telephone: 805 967-1153
FAX: 805 967-1295

Website: www.tecfe.com
email: tecfe@tecfe.com

IOL KNIVES AND BLADES - ROUND STOCK, 6/box

TE-903064	IOL 3.0MM KNIFE ANGLED
TE-903264	IOL 3.2MM KNIFE ANGLED
TE-903564	IOL 3.5MM KNIFE ANGLED
TE-903864	IOL 3.8MM KNIFE ANGLED
TE-904001	IOL 4.0MM KNIFE STRAIGHT
TE-904061	IOL 4.0MM KNIFE ANGLED
TE-904161	IOL 4.1MM KNIFE ANGLED
TE-905101	IOL 5.1MM KNIFE STRAIGHT
TE-905161	IOL 5.1MM KNIFE ANGLED
TE-905201	IOL 5.2MM KNIFE STRAIGHT
TE-905261	IOL 5.2MM KNIFE ANGLED
TE-905601	IOL 5.5MM KNIFE STRAIGHT
TE-905661	IOL 5.5MM KNIFE ANGLED
TE-906101	IOL 6.0MM KNIFE STRAIGHT
TE-906161	IOL 6.0MM KNIFE ANGLED
TE-906261	IOL 6.2MM KNIFE ANGLED

IOL KNIVES AND BLADES - FLAT STOCK, 6/box

TE-4732	IOL 4.0 BLADE ANGLED BEVEL DOWN
TE-4732BU	IOL 4.0 BLADE ANGLED BEVEL UP
TE-4742	IOL 4.0MM KNIFE ANGLED
TE-4742BU	IOL 4.0MM KNIFE ANGLED BEVEL UP
TE-4736	IOL 5.1MM BLADE ANGLED
TE-4736BU	IOL 5.1MM BLADE ANGLED BEVEL UP
TE-4746	IOL 5.1MM KNIFE ANGLED
TE-4746BU	IOL 5.1MM KNIFE ANGLED BEVEL UP
TE-5590	IOL 5.2MM BLADE ANGLED
TE-5590BU	IOL 5.2MM BLADE ANGLED BEVEL UP
TE-5590H	IOL 5.2MM KNIFE ANGLED
TE-5590HBU	IOL 5.2MM KNIFE ANGLED BEVEL UP
TE-5591*	IOL 5.2MM BLADE STRAIGHT
TE-5591H*	IOL 5.2MM KNIFE STRAIGHT
TE-4748	IOL 6.2MM KNIFE ANGLED
TE-4748BU	IOL 6.2MM KNIFE ANGLED BEVEL UP

MINIATURE BLADES AND KNIVES

TE-4764	KNIFE ROUND TIP SHARP 1 SIDE
TE-4769	KNIFE ROUND TIP
TE-6100	CHISEL BLADE SMALL 1.5MM
TE-6200	CHISEL BLADE 2.7MM
TE-6300	BLADE POINT-TIP
TE-6400	BLADE ROUND-TIP SHARP 1 SIDE
TE-6460	BLADE 60 DEGREES ANGLED
TE-6500	BLADE 15 DEGREE POINTED
TE-6700	BLADE CURVED, SHARP 1 SIDE
TE-6900	BLADE ROUND TIP
TE-6910	BLADE ROUND TIP ANGLED



MINI BLADES AND KNIVES

TE-4764	MINIATURE KNIFE ROUND TIP SHARP 1 SIDE	6/box
TE-4769	MINIATURE KNIFE ROUND TIP	6/box
TE-6100	MINIATURE CHISEL BLADE SMALL 1.5MM	12/box
TE-6200	MINIATURE CHISEL BLADE 2.7MM	12/box
TE-6300	MINIATURE BLADE POINT-TIP	6/box
TE-6400	MINIATURE BLADE ROUND-TIP SHARP 1 SIDE	12/box
TE-6460	MINIATURE BLADE 60 DEGREES ANGLED	6/box
TE-6500	MINIATURE BLADE 15 DEGREE POINTED	12/box
TE-6700	MINIATURE BLADE CURVED, SHARP 1 SIDE	12/box
TE-6900	MINIATURE BLADE ROUND TIP	6/box
TE-6910	MINIATURE BLADE ROUND TIP ANGLED	6/box

MICRO INCISION MVR KNIVES, 6/box

TE-965564	MVR 25G KNIFE
TE-965569	MVR 25G KNIFE ANGLED

MVR KNIVES, 6/box

TE-965561	MVR 19G KNIFE
TE-965566	MVR 19G KNIFE ANGLED
TE-965560	MVR 20G KNIFE
TE-965565	MVR 20G KNIFE ANGLED
TE-965562	MVR 23G KNIFE
TE-965567	MVR 23G KNIFE ANGLED

PRECISE DEPTH KNIVES AND BLADES, 6/box

TE-5435	P.D.I.-PRECISE DEPTH INCISION BLADE 0.35MM DEPTH
TE-5485	P.D.I.-PRECISE DEPTH INCISION KNIFE 0.35MM DEPTH
TE-5440	P.D.I.-PRECISE DEPTH INCISION BLADE 0.40MM DEPTH
TE-5486	P.D.I.-PRECISE DEPTH INCISION KNIFE 0.40MM DEPTH
TE-5450	P.D.I.-PRECISE DEPTH INCISION BLADE 0.50MM DEPTH
TE-5490	P.D.I.-PRECISE DEPTH INCISION KNIFE 0.50MM DEPTH
TE-5460	P.D.I.-PRECISE DEPTH INCISION BLADE 0.60MM DEPTH
TE-5491	P.D.I.-PRECISE DEPTH INCISION KNIFE 0.60MM DEPTH

HANDLES, 1/box

TE-1305	CROSS CUT COLLET
TE-1311	5CM HANDLE
TE-1312	7.5CM HANDLE
TE-1310	10CM HANDLE
TE-1330	10CM HEX HANDLE
TE-1350	13CM HANDLE
TE-1360	13CM HEAVY DUTY HANDLE
TE-1320	15.5CM STAINLESS HANDLE
TE-1340	15.5CM HEX HANDLE

OTHER BLADES AND KNIVES, 6/box

TE-6600	LAMELLAR BLADE ANGLED BEVEL UP
TE-6610	LAMELLAR BLADE STRAIGHT
TE-5940	NEEDLE BLADE 1.5MM
TE-5910	NEEDLE BLADE 3.0MM
TE-5920	NEEDLE BLADE 5.0MM
TE-5930	NEEDLE BLADE 7.0MM
TE-6805	NEEDLE BLADE EUROPEAN STYLE
TE-5700	SCLERAL BLADE
TE-5700S	SCLERAL BLADE SMALL
TE-5710	SCLERAL KNIFE
TE-5710S	SCLERAL KNIFE SMALL

OTHER BLADES AND KNIVES, 12/box

TE-7615	15 DEGREE MICRO BLADE ANGLED
TE-7622	22 DEGREE MICRO BLADE ANGLED
TE-7630	30 DEGREE MICRO BLADE ANGLED
TE-7645	45 DEGREE MICRO BLADE ANGLED



Trephine Blades, Traditional, Non-Vacuum, and Vacuum



Traditional Corneal Trephines

- Long and short styles
- Compatible with most punch systems
- Reproducible results
- Range 3.00 to 18.00 mm long and 6.00 to 9.00 mm short
- Eye Bank sizes available

LONG TREPHINES

TE-330300, 3.00mm Diameter	TE-330900, 9.00mm Diameter
TE-330400, 4.00mm Diameter	TE-330950, 9.50mm Diameter
TE-330450, 4.50mm Diameter	TE-331000, 10.00mm Diameter
TE-330500, 5.00mm Diameter	TE-331050, 10.50mm Diameter
TE-330550, 5.50mm Diameter	TE-331100, 11.00mm Diameter
TE-330575, 5.75mm Diameter	TE-331150, 11.50mm Diameter
TE-330600, 6.00mm Diameter	TE-331200, 12.00mm Diameter
TE-330625, 6.25mm Diameter	TE-331250, 12.50mm Diameter
TE-330650, 6.50mm Diameter	TE-331300, 13.00mm Diameter
TE-330675, 6.75mm Diameter	TE-331350, 13.50mm Diameter
TE-330700, 7.00mm Diameter	TE-331400, 14.00mm Diameter
TE-330725, 7.25mm Diameter	TE-331450, 14.50mm Diameter
TE-330750, 7.50mm Diameter	TE-331500, 15.00mm Diameter
TE-330775, 7.75mm Diameter	TE-331550, 15.50mm Diameter
TE-330785, 7.85mm Diameter	TE-331600, 16.00mm Diameter
TE-330800, 8.00mm Diameter	TE-331650, 16.50mm Diameter
TE-330825, 8.25mm Diameter	TE-331700, 17.00mm Diameter
TE-330850, 8.50mm Diameter	TE-331800, 18.00mm Diameter
TE-330875, 8.75mm Diameter	Packaged sterile, one per package

SHORT TREPHINES

TE-310600 , 6.00mm Diameter
TE-310625 , 6.25mm Diameter
TE-310650 , 6.50mm Diameter
TE-310675 , 6.75mm Diameter
TE-310700 , 7.00mm Diameter
TE-310725 , 7.25mm Diameter
TE-310750 , 7.50mm Diameter
TE-310775 , 7.75mm Diameter
TE-310800 , 8.00mm Diameter
TE-310825 , 8.25mm Diameter
TE-310850 , 8.50mm Diameter
TE-310875 , 8.75mm Diameter
TE-310900 , 9.00mm Diameter

Packaged sterile, one per package

TREPHINE System & Components



- TE-330010**
Corneal Punch System
- 7-9.0mm Punch Piston
 - Piston Holder
 - Base Plate



Punch Piston

- TE-330005** 5-7.0mm Punch Piston
- TE-330007** 7-9.0mm Punch Piston
- TE-330009** 9-11.0mm Punch Piston
- TE-330001** Disposable Corneal Block (sterile)



NON-VACUUM TREPHINE PUNCHES

TE-340600, 6.00mm Diameter
TE-340625, 6.25mm Diameter
TE-340650, 6.50mm Diameter
TE-340675, 6.75mm Diameter
TE-340700, 7.00mm Diameter
TE-340725, 7.25mm Diameter
TE-340750, 7.50mm Diameter
TE-340775, 7.75mm Diameter
TE-340800, 8.00mm Diameter
TE-340825, 8.25mm Diameter
TE-340850, 8.50mm Diameter
TE-340875, 8.75mm Diameter
TE-340900, 9.00mm Diameter
TE-340950, 9.50mm Diameter

- Posts ensure proper alignment
- Reliable performance
- Complete system Range 6.00 to 9.50mm



Packaged sterile, one per package

VACUUM TREPHINES

- Unsurpassed sharpness and consistency
- Access to all eyes, regardless of depth
- Non-slip rings on finger grips assist with handling when gloves wet
- Range 6.00 to 9.50 mm

TE-350600, 6.00mm Diameter
TE-350625, 6.25mm Diameter
TE-350650, 6.50mm Diameter
TE-350675, 6.75mm Diameter
TE-350700, 7.00mm Diameter
TE-350725, 7.25mm Diameter
TE-350750, 7.50mm Diameter
TE-350775, 7.75mm Diameter
TE-350800, 8.00mm Diameter
TE-350825, 8.25mm Diameter
TE-350850, 8.50mm Diameter
TE-350875, 8.75mm Diameter
TE-350900, 9.00mm Diameter
TE-350950, 9.50mm Diameter

Packaged sterile, one per package



Non-slip finger grips



Assorted Hard-to-find Ophthalmic Products



Half Eye Readers, Clear Lens

Available in Diopter +1.00 to +4.00, 12/box
Comfortable fit, plated aluminum temples and acrylic

25100	+1.00 Diopter	25275	+2.75 Diopter
25125	+1.25 Diopter	25300	+3.00 Diopter
25150	+1.50 Diopter	25325	+3.25 Diopter
25175	+1.75 Diopter	25350	+3.50 Diopter
25200	+2.00 Diopter	25375	+3.75 Diopter
25225	+2.25 Diopter	25400	+4.00 Diopter
25250	+2.50 Diopter		



Post Mydriatic Sunglasses

5108A Solarettes, with Side Shields, 400/case

- Flexible
- 400 pieces per case
- Fits all sizes
- 100% UVA/UVB Protection

TE-501030 Fluid Filter Sterile, 0.20 micron, 50 pieces/bag



Post Op Bags for Cataract or Refractive Kits

B4-W Clear Vinyl Zipper Case

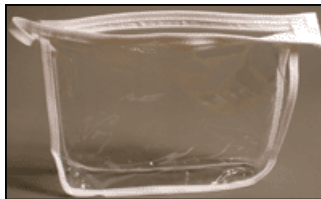

4308N Navy Zipper Bag



4300B Black Hip Zipper Bag



Reusable Hot/Cold Cryogenic Eye Compress

CE-100 Unilateral Eye Compress

CE-102 Bilateral Eye Compress



5385 Hollister Avenue, No. 216
Santa Barbara, CA 93111 U.S.A.

Telephone: 805 967-1153
FAX: 805 967-1295

Website: www.tecfe.com
email: tecfe@tecfe.com

Otological Ventilation Tubes: Sterile & BULK

SHEPARD

Classic, popular grommet design for easy insertion, adequate ventilation and short term duration.

Fluoroplastic

TE-7007-CE, 1.0mm I.D. With wire to facilitate easy removal

TE-7008-CE, 1.0mm I.D. Without wire

TE-7011-CE, 1.14mm I.D. With wire to facilitate easy removal

TE-7014-CE, 1.14mm I.D. Without wire



SHAH

Similar to SHEPARD design with extended tab or wire on outer flange to facilitate insertion. **Addition** of "Shoehorn" elongated tongue on inner flange allows smaller incision and easier insertion and helps prevent early extrusion.

Polyethylene

TE-7016-CE,
1.1mm I.D. With Tab



Fluoroplastic

TE-7018-CE,
1.1mm I.D. With Wire



**All Tubes available in
NON-STERILE, bulk packaged
at reduced prices**

DONALDSON

Popular ventilation tube due to its straightforward design which resists extrusion. **Silicone** material offers elasticity for easy insertion.

Silicone



TE-7024-CE, 1.1mm I.D. With tab to facilitate easy removal

TE-7025-CE, 1.14mm I.D. Without tab



5860-C Hollister Avenue
Santa Barbara, CA 93117 U.S.A.

Telephone: 805 967-1153
FAX: 805 967-1295

Website: www.tecfe.com
email: tecfe@tecfe.com

PAPARELLA Unique design of notched inner flange facilitates insertion through simple "twist-in" movement. **Very** stable for long-term implantation. Integral tab for removal with forceps. **Type Two** is a long-term design similar to the short-term Type One. It has large inner flange allowing easy placement and 1.5mm inner diameter to help prevent blockage.

Silicone

TE-7026-CE,
1.14mm I.D.
With integral tab

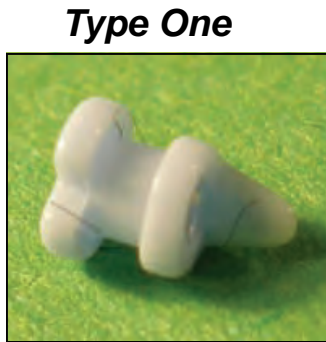

TE-7076-CE,
1.42mm I.D.
With integral tab



BEVEL BOBBIN

Fluoroplastic

Combining the best features of the Baxter Bevel Button and the Reuter Bobbin, the beveled shape resists occlusion and clears easily.

TE-7029-CE 1.14mm I.D.
Without wire



ARMSTRONG

Polyethylene

TE-7056-CE, 1.2mm I.D.
Grommet Type
Short Shaft



**All Tubes available in
NON-STERILE, bulk packaged
at reduced prices**

T-TUBE

Silicone

The T-flange and long shaft design keep the tube firmly positioned giving the surgeon complete control over length of ventilation time. **The** silicone material allows soft flanges to collapse easily for introduction through a very small incision and safe and comfortable removal at any time. **Can** be easily trimmed to adapt to the surgeon's needs.

TE-7089-CE, 1.14mm I.D.
*Pre-trimmed, 8mm Length,
2mm Flanges*



TE-7091-CE, 1.14mm I.D.
*12mm Length,
4mm Flanges*



5860-C Hollister Avenue
Santa Barbara, CA 93117 U.S.A.

Telephone: 805 967-1153
FAX: 805 967-1295

Website: www.tecfe.com
email: tecfe@tecfe.com

MicroPick™ Ear Pick



PX-1000 MicroPick Straight Tip - 1 per pouch, 6 per box **STERILE**

PX-1045 MicroPick Angled Tip, 45 deg. - 1 per pouch, 6 per box **STERILE**

PX-1090 MicroPick Angled Tip, 90 deg. - 1 per pouch, 6 per box **STERILE**

BL-1425 Stainless Steel Handle, non-sterile, multiple use

- Single-use, sterile, disposable ear pick tips for delicate procedures
- Molded adaptor fits into most myringotomy blade handles
- Malleable shaft bends to surgeon's preference
- Available in straight, 45 and 90 degree angles

Developed in cooperation with Dr. Jay Farior, the affordable, single-use MicroPick™ Ear Pick Tips feature three tip designs to ensure a new, precise tip for every procedure. The malleable shaft enables positioning in a nearly infinite number of angles to be fine tuned for surgical requirements. Each MicroPick Ear Pick Tip features a molded adaptor that can be threaded into Tecfen's Stainless Steel handle or most commonly used flat 'Beaver-style' myringotomy blade handles found on the market.

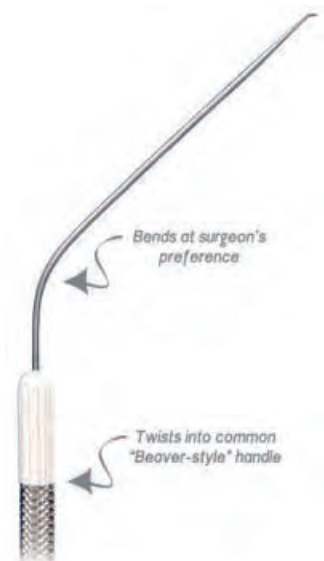

5860-C Hollister Avenue
Santa Barbara, CA 93117 U.S.A.

Telephone: 805 967-1153
FAX: 805 967-1295

Website: www.tecfe.com
email: tecfe@tecfe.com

Eavey E3 Ear Wrap



SB-41400 Single Ear

Surgeon Features

- Time and money savings
- Adjustable
- One size fits all
- Use on either ear
- Change quick and easily
- Easily repositioned
- Easily replaced
- Used in combination with familiar cotton and gauze absorbent materials

Patient Features

- Extremely comfortable
- Safe sleeping
- Easily repositioned
- Easily replaced at home following surgical instructions

Surgical External Post-Operative Dressing

**Developed in conjunction with Roland D. Eavey, M.D.,
Massachusetts Eye & Ear Infirmary**

Instructions:

In the operating room, apply the conventional absorbent material such as cotton and gauze to the operated ear. Place the widest part over the operated ear and absorbent materials. Wrap the band around the head and use the velcro to secure. The wrap is placed at the same level one would have placed a conventional dressing.



Physician's Choice Head Bands



The majority of Otolaryngologists and Hearing Health Care Professionals in the U.S. believe that patients who wear ear protection, especially custom-molded protectors or preformed rubber ear plugs, should also wear a tight-fitting cap or band for extra protection when swimming or showering.

Use of the **PHYSICIANS' CHOICE** Headband is an effective, stylish, and comfortable way of keeping water out of the ears and ear protectors in place.

Available in a variety of colors and sizes:

SB-41206 SMALL Ages 18 months - 4 years

SB-41207 MEDIUM Ages 5 - 10 years

SB-41208 LARGE Ages 11 years - Adult

SB-41209 X-LARGE

Velcro closure allows easy adjustments

Comfortable fit

Fabricated from wet-suit neoprene material

Reversible - dual colored.

The **PHYSICIANS' CHOICE** Head Band is happily worn by boys and girls.



5860-C Hollister Avenue
Santa Barbara, CA 93117 U.S.A.

Telephone: 805 967-1153
FAX: 805 967-1295

Website: www.tecfe.com
email: tecfe@tecfe.com

Nasal Sponges

AbsorbENT™ Nasal and Sinus Packing













We offer the most popular designs for nasal and sinus packing including Doyle Patient-Friendly Anatomic Nasal Packs. AbsorbENT™ Nasal and Sinus Packs consist of three-dimensional, interconnected open cells that are extremely soft and pliable. This interconnected structure produces packing that is exceptionally strong, highly absorbent and virtually lint and fiber free.

Soft, Absorbent, Lint and Fiber Free! AbsorbENT™ Nasal and Sinus Packs Feature

- Rounded edges for patient comfort during removal
- Even expansion for desired gentle mucosal pressure
- Rapid wicking of blood and fluid
- Individually sterile packaged

Nasal and Sinus Packing

AbsorbENT™ Nasal and Sinus Packs are compressed for easy placement. Upon exposure to fluids, the pack expands to six times its compressed size to fill the cavity and provide gentle pressure and support of tissues.

Product No.	Description	Packs/Box	Product Image
RH-2310-10	Epistaxis Pack with String, Large 10.0cm long x 1.5cm wide x 2.5cm thick	10	
RH-2315-20	Epistaxis Pack with String, Small 5.5cm long x 1.5cm wide x 2.5cm thick	20	
RH-7401-10	Nasal Packing 4.5cm long x 1.5cm wide x 2.0 cm high	10	
RH-7404-10	Nasal Packing 8.0cm long x 1.5cm wide x 2.0cm high	10	
RH-7405-10	Nasal Packing with Airway and String 8.0cm long x 1.5cm wide x 2.0cm thick	10	
RH-7408-10	Nasal Packing with Airway and String 4.5cm long x 1.5cm wide x 2.0cm thick	10	
RH-7409-10	Nasal Packing, Anatomical with String 8.0cm long x 1.5cm wide x 3.0cm thick	10	
RH-7410-10	Nasal Packing, Anatomical with Airway and String 8.0cm long x 1.5cm wide x 3.0cm thick	10	
RH-7406-10	Nasal Packing, Thin 8.0cm long x 1.0cm wide x 2.0cm thick	10	
RH-7411-10	Nasal Packing, Thin Anatomical 8.0cm long x 1.0cm wide x 3.0cm thick	10	
RH-7530-10	Sinus Packing with String 3.5cm long x 0.6cm wide x 1.2cm thick	10*	
RH-7532-10	Sinus Packing with String 3.5cm long x 0.9cm wide x 1.2cm thick	10*	

Doyle Patient Friendly™ Nasal Packs



Tecfen Corporation

5860-C Hollister Avenue
Santa Barbara, CA 93117 U.S.A



Tel: (805) 967 1153
Fax: (805) 967 1295



Home: www.tecfe.com
Email: tecfe@tecfe.com

We offer the most popular designs for nasal and sinus packing including Doyle Patient-Friendly Anatomic Nasal Packs. AbsorbENT™ Nasal and Sinus Packs consist of three-dimensional, interconnected open cells that are extremely soft and pliable. This interconnected structure produces packing that is exceptionally strong, highly absorbent and virtually lint and fiber free.

Soft, Absorbent, Lint and Fiber Free! AbsorbENT™ Nasal and Sinus Packs Feature



- Rounded edges for quick and easy insertion
- Even expansion for desired gentle mucosal pressure
- Rapid wicking of blood and fluid
- Individually sterile packaged

Doyle Patient Friendly™ Nasal Packs*

Doyle Patient-Friendly Nasal Packs are sterile, anatomically shaped, compressed AbsorbENT™ Sponges. The pack is precut from back to front except for a web at the distal end. The pack is inserted and functions like a standard anatomical nasal pack. On removal, the pack is pulled slightly out of the nasal cavity to expose the uncut web. The web is then cut through with

scissors, which separates the pack into two parts. The two parts are removed one at a time, greatly reducing patient discomfort.



Inserted into nasal fossa



Pull out slightly and cut through remaining web



Remove two parts one at a time

*Developed in cooperation with Donald Doyle, MD, FACS

Product No.	Description	Packs/Box	Product Image
RH-7412-10	Doyle Patient Friendly Anatomical Nasal Packing with String 8.0cm long x 1.5cm wide x 3.0cm thick	10	
RH-7413-10	Doyle Patient Friendly Anatomical Nasal Packing with Airway Tube 8.0cm long x 1.5cm wide x 3.0cm thick	10	
RH-7414-10	Doyle Patient Friendly Anatomical Nasal Packing with String, Thin 8.0cm long x 1.0cm wide x 3.0cm thick	10	



Tecfen Corporation

5860-C Hollister Avenue
Santa Barbara, CA 93117 U.S.A



Tel: (805) 967 1153
Fax: (805) 967 1295



Home: www.tecfe.com
Email: tecfe@tecfe.com

Silicone Sheeting

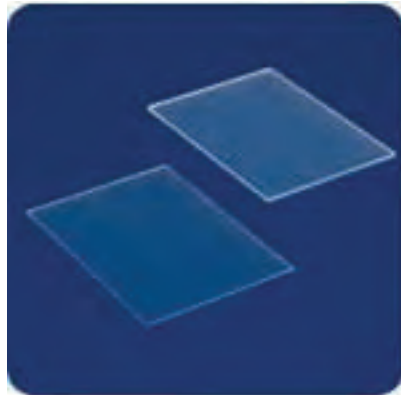

Sterile, single-use

This medical-grade, custom-cut Silicone Sheeting is designed to be trimmed by the surgeon for custom applications.

Two thicknesses available: 1mm and 0.5mm

SP-65000 Silicone Sheeting 1mm x 56mm x 76mm
- 1 per package/10 per box

SP-65100 Silicone Sheeting 0.5mm x 56mm x 76mm
- 1 per package/10 per box



Epistax™ Balloon Catheter



- Made from soft, medical-grade silicone for patient comfort
- Beveled posterior tip and soft silicone construction allow for easy placement and prevents adhesion for easy removal
- Designed to control intranasal bleeding with a two-balloon epistaxis catheter:
- Small balloon controls posterior bleeding, large balloon controls anterior bleeding

The Epistax™ Epistaxis Balloon Catheter is available with or without an inflation syringe. The optional syringe is used to expand the balloons with normal saline. The volume of saline injected determines the size and pressure of the balloons, resulting in a controlled, uniform pressure to manage bleeding. The integral airway tube allows for nasal breathing while the balloons are inflated.

EPISTAXIS CATHETER WITH INTEGRAL AIRWAY

RH-4200-01 97mm Double Balloon - 1 per package, 1 per box

RH-4220-01 97mm Double Balloon with 20cc syringe, 1 per package, 1 per box

RH-4400-01 120mm Double Balloon 1 per package, 1/box

RH-4420-01 120mm Double Balloon with 20 cc syringe, 1 per package, 1/box



5860-C Hollister Avenue
Santa Barbara, CA 93117 U.S.A.

Telephone: 805 967-1153
FAX: 805 967-1295

Website: www.tecfe.com
email: tecfe@tecfe.com

DeVilbiss® Atomizers and Tips



Use convenient, single-use RhinoGuard™ Tip Covers on your DeVilbiss products to reduce cross contamination, increase comfort for your patients and eliminate the need to decontaminate products over and over.



ATOMIZER

Ultra-fine particle atomization of most medical solutions

Straight flow tip is easily disassembled for cleaning

Suitable for applying fine, medicated spray to nasal and oral cavities, or oral vaccines

May be used with compressed air, the No.1 bulb or No. 630 cut-off assembly

Model DV-286

Atomizer, clear glass with metal top
1 per package/non-sterile



ATOMIZER

Designed for quick change and replacement of spray tube

Tight fitting "O" ring ensures consistent spray

Metal spray tube may be sterilized after each use

Adjustable tip permits up or down spray for aqueous solutions of heavier viscosity

Operated by the No.630 cutoff assembly or a No. 1 bulb

Model DV-163

Atomizer, amber glass with metal top
1 per package/non-sterile

RHINO-GUARD ATOMIZER TIP PROTECT

SP-30010 100 per box/non-sterile

SP-30250 250 per box/non-sterile



5860-C Hollister Avenue
Santa Barbara, CA 93117 U.S.A.

Telephone: 805 967-1153
FAX: 805 967-1295

Website: www.tecfe.com
email: tecfe@tecfe.com

Silicone Ear Putty® Plugs



Designed to help protect the user's ears against damaging noise levels, prevent or eliminate water retention in the ear canal, and remove excess ear-wax buildup.

- Pliable and moldable
- Silicone, a polymer that is hypoallergenic and water repellent
- Easily inserted and removed with no residue or "clean-up"
- Packed and stored in plastic storage containers for reuse
- Two plugs per plastic container



SB-30002
small plastic carrying case
2 plugs/case



SB-30024
small plastic carrying case
Packaged in shrink-wrap
24 cases per display box
2 plugs/case



SB-30108
small plastic carrying case
8 plugs on a display card



CE



Infection Control Glasses, Goggles, Face Masks, & Face Shields



- Worn Alone
- Vented Sides
- Latex Safe
- Fits over prescription glasses
- Anti-Fog
- 99.9% UV protection



One size

Clear, lightweight plastic glasses provide wrap-around fluid protection and an extremely comfortable fit. Embrace Protective Glasses

Model No. 11000-300

Frame Clear



- UV400 Polycarbonate Lens
- Scratch Resistant Coating
- Lightweight Frames

Model No. 60S43CHS

Frame Clear



Complete peripheral protection with enhanced comfort.

SILO Wear Alone

One size



- Worn Alone
- Vented Sides
- Latex Safe
- Easily adjustable elastic strap
- Optical quality lenses for clarity of vision
- 99.9% UV protection

Sturdy, comfortable, snug-fitting for excellent fluid protection. Vented for additional comfort and reduced fogging.

Model No. 11000-328

Frame Clear

One size

Embrace Protective Goggles



5860-C Hollister Avenue
Santa Barbara, CA 93117 U.S.A

Tel: (805) 967 1153
Fax: (805) 967 1295

Home: www.tecfe.com
Email: tecfe@tecfe.com

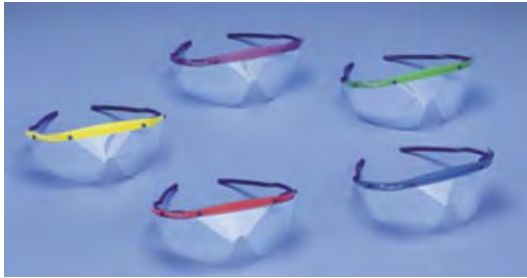

- Worn Alone
- Wrap-around frame
- Secure & comfortable fit
- Non perforated lenses
- Anti-fog on both sides
- Top-down fluid protection ridge
- Fits over prescription glasses
- Latex Safe

The shield can be replaced in a matter of seconds providing extremely economical eye fluid protection.

Model No.
11000-500

Frame
Assorted colors

One size

Embrace Cool Shieldz



- Filtration: 99+% filtration at .1 micron particles
- Anti fog eye shield (both sides)
- Fluid resistant face mask
- Attached Fluid Shield
- Fiberglass Free
- Latex Safe

Pleated, comfortable and fluid resistant protective face mask that breathes extremely well.

Model No.
11000-400 Ties (Surgical)
11000-410 Ear Loop (Procedure)

One size

Embrace Protective Face Mask



- Anti-Fog (Both Sides)
- Anti-Stat
- Optically clear
- Latex Safe



Soft elastic or adjustable Velcro strap

Model No.
11000-000 Velcro Strap
11000-001 Elastic Strap

One size

Embrace Splash Mask Face Shield



General & Utility Surgical Drapes

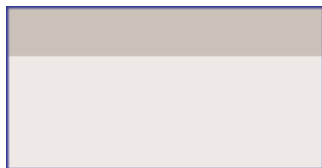

Towel Drape

D1000 Size: 45 cm x 30 cm

D1010 Size: 45 cm x 60 cm

Adhesive: 45 cm x 3.8 cm

USE: Prepping, tourniquet and instrument cover, squaring off, isolating sterile from non-sterile areas, fluid barrier, non-



PREP-Drape®

Towel Drape on a roll

D1000RL Size: 45 cm x 30 cm

D1010RL Size: 45 cm x 60 cm

Adhesive: 45 cm x 3.8 cm

USE: Prepping, tourniquet and instrument cover, isolating sterile from non-sterile areas, fluid barrier



D1003 Isolation Bag

Size: 50 cm x 50 cm

USE: Isolate foot, hand, bowel, organs

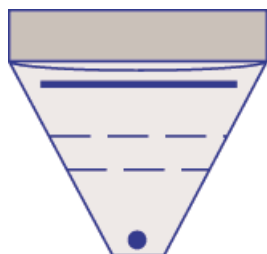

D1016 Fluid Drape

Size: 50 cm x 48 cm

Adhesive: 50 cm x 10 cm

USE: CV, orthopedic, Neurologic, urologic and general

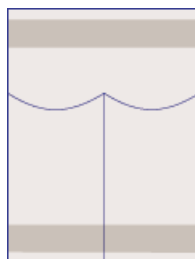

D1018 Instrument Pouch

Size: 17 cm x 30 cm

Adhesive: (2) 17 cm x 5 cm

USE: Neurologic, orthopedic, back, CV, general

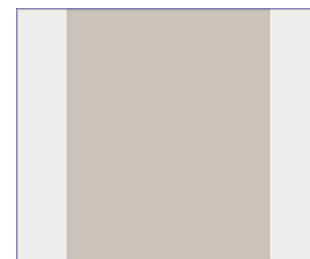

Incise Drape

D1040 Size: 60 cm x 35 cm

Adhesive: 35 cm x 35 cm

D1050 Size: 91 cm x 44 cm

Adhesive: 59 cm x 44 cm

USE: Neurologic, orthopedic, back, CV, general



5860-C Hollister Avenue
Santa Barbara, CA 93117 U.S.A.

Telephone: 805 967-1153
FAX: 805 967-1295

Website: www.tecfe.com
email: tecfe@tecfe.com

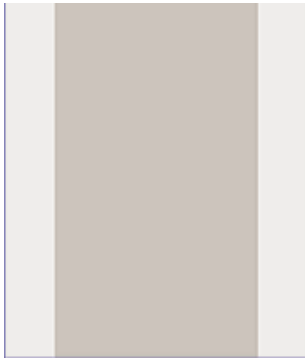

Incise Drape

D1051 Size: 91cm x 83 cm

Adhesive: 59 cm x 83 cm

USE: CV, chest and back

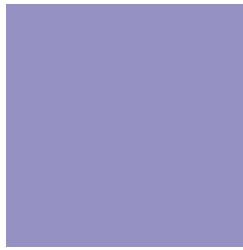

D1089 Utility Drape

(2 Drapes per package)

Size: 60 cm x 66 cm

USE: Utility and tray cover

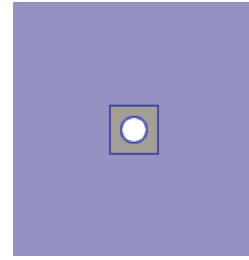

D1092 Minor Procedure Drape

Size: 60 cm x 66 cm

Adhesive: 11 cm x 12 cm

Aperture: 6 cm circle

USE: Lumbar puncture, lacerations, minor eye and ear

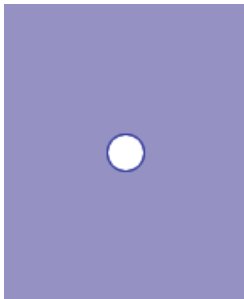

D2147 Aperture Drape

Size: 137 cm x 139 cm

Aperture: 10 cm circle

USE: ENT, general and utility

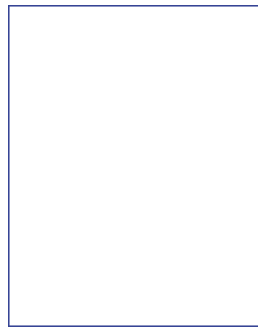

Clear Cover

D2007 Size: 91 cm x 111 cm

D2008 Size: 111 cm x 182 cm

USE: Back table cover, barrier sheet, set up cover



D2158 Instrument Cover

Size: 60 cm x 45 cm

Adhesive: 60 cm x 1.2cm

USE: Cover instruments, mayo stand, monitor



5860-C Hollister Avenue
Santa Barbara, CA 93117 U.S.A.



Telephone: 805 967-1153
FAX: 805 967-1295



Website: www.tecfe.com
email: tecfe@tecfe.com

ACTI-Gard Antimicrobial Drapes

D6648 ACTI-Gard® Antimicrobial Incise Drape

Effectively reduces the levels of microorganisms associated with post-operative infection. Cost-effective: available bulk nonsterile for use in procedural packs/trays. Antimicrobial: revolutionary stable iodine complex. Nonirritating and nonsensitizing.

Adhesive Area:

23.5" x 23.5" (60 cm x 60 cm)

Sterile Quantity: 10/bx

D6648

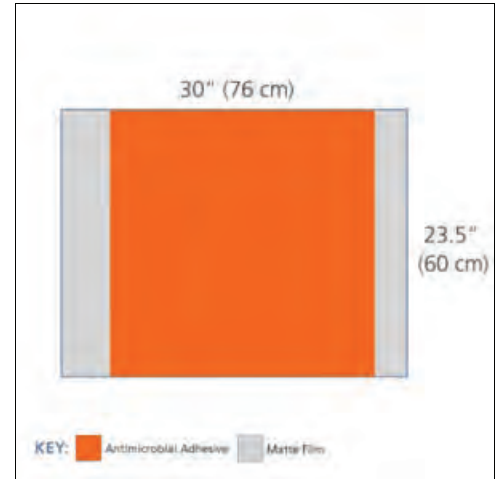

D6650 ACTI-Gard® Antimicrobial Incise Drape

Effectively reduces the levels of microorganisms associated with post-operative infection. Cost-effective: available bulk nonsterile for use in procedural packs/trays. Antimicrobial: revolutionary stable iodine complex. Nonirritating and nonsensitizing.

Adhesive Area:

23.5" x 18" (60 cm x 50 cm)

Sterile Quantity: 10/bx

D6650

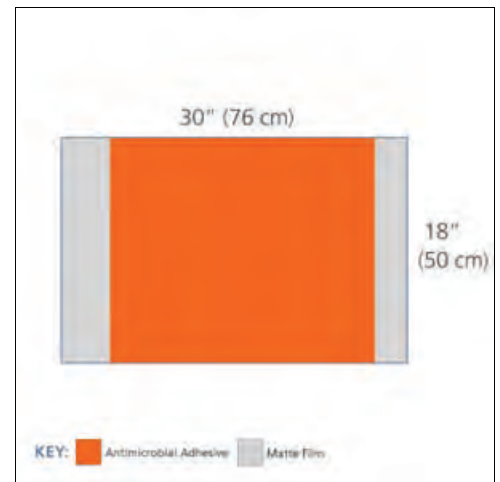

D6640 ACTI-Gard® Antimicrobial Incise Drape

Effectively reduces the levels of microorganisms associated with post-operative infection. Cost-effective: available bulk nonsterile for use in procedural packs/trays. Antimicrobial: revolutionary stable iodine complex. Nonirritating and nonsensitizing.

Adhesive Area:

14" x 14" (35 cm x 35 cm)

Sterile Quantity: 10/bx

D6640

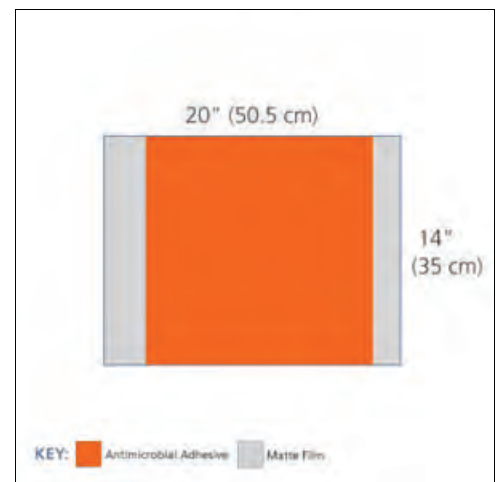

5385 Hollister Avenue, No. 216
Santa Barbara, CA 93111 U.S.A.

Telephone: 805 967-1153
FAX: 805 967-1295



Website: www.tecfe.com
email: tecfe@tecfe.com

ACTI-Gard Antimicrobial Drapes

D6635 ACTI-Gard® Antimicrobial Incise Drape

Effectively reduces the levels of microorganisms associated with post-operative infection. Cost-effective: available bulk nonsterile for use in procedural packs/trays. Antimicrobial: revolutionary stable iodine complex. Nonirritating and nonsensitizing.

Adhesive Area:

4" x 7.5" (10 cm x 19 cm)

Sterile Quantity: 10/bx

D6635

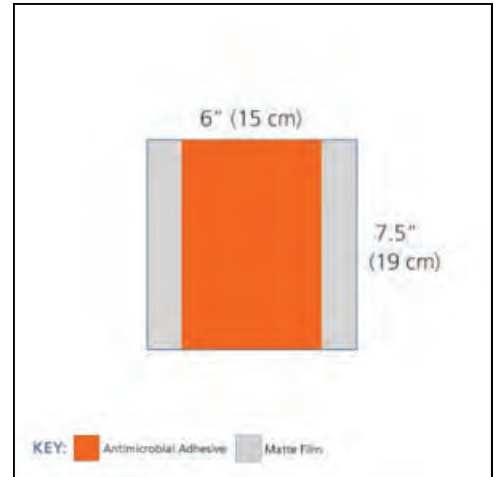

D6651 ACTI-Gard® Antimicrobial Incise Drape

Effectively reduces the levels of microorganisms associated with post-operative infection. Cost-effective: available bulk nonsterile for use in procedural packs/trays. Antimicrobial: revolutionary stable iodine complex. Nonirritating and nonsensitizing.

Adhesive Area:

23.5" x 35.5" (60 cm x 90 cm)

Sterile Quantity: 10/bx

D6651

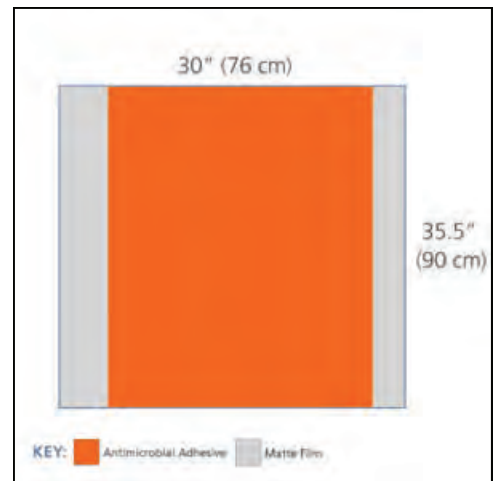

5385 Hollister Avenue, No. 216
Santa Barbara, CA 93111 U.S.A.

Telephone: 805 967-1153
FAX: 805 967-1295



Website: www.tecfe.com
email: tecfe@tecfe.com

ACTI-Gard Antimicrobial Drapes

D6617 ACTI-Gard® Antimicrobial Patient Isolation Drap

Effectively reduces the levels of microorganisms associated with post-operative infection. Cost-effective: available bulk nonsterile for use in procedural packs/trays. Antimicrobial: revolutionary stable iodine complex. Nonirritating and nonsensitizing

Adhesive Area:

419" x 14" (48 cm x 35 cm)

Adhesive Strip:

125" x .5" (317 cm x 1.3 cm)

Fluid Pouch:

20" x 19" (51 cm x 48 cm)

Instrument Pouches:

(2) 6.7" x 11.5" (17 cm x 29 cm)

Sterile Quantity: 5/bx

D6617

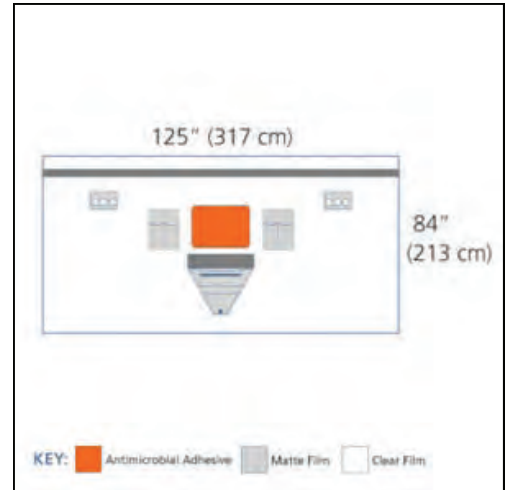

D6657 ACTI-Gard® Antimicrobial Cesarean Incise Pouch

Effectively reduces the levels of microorganisms associated with post-operative infection. Cost-effective: available bulk nonsterile for use in procedural packs/trays. Antimicrobial: revolutionary stable iodine complex. Nonirritating and nonsensitizing .

Adhesive Area:

14" x 14.5" (35 cm x 36 cm)

Sterile Quantity: 10/bx

D6657

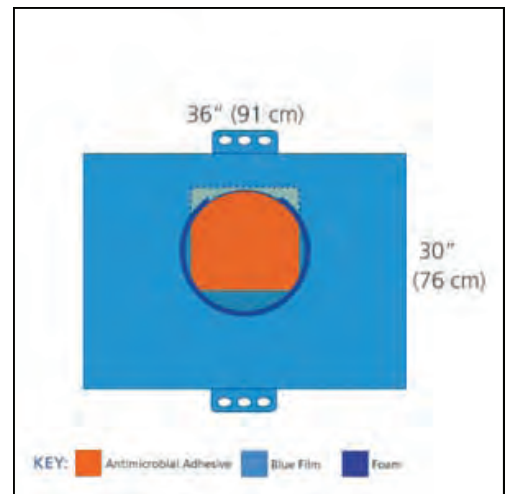

5385 Hollister Avenue, No. 216
Santa Barbara, CA 93111 U.S.A.

Telephone: 805 967-1153
FAX: 805 967-1295



Website: www.tecfe.com
email: tecfe@tecfe.com

Thermometer, Digital Forehead Liquid Crystal

Guardian Liquid Crystal Thermometer

Precise display of body temperature is indicated in 1/2 degree temperature increments. Within 15 seconds the core temperature of the individual is indicated in easy-to-read windows.

- Does not break
- Available in Celcius or Fahrenheit
- Indicates temperature in 15 seconds
- Save, no risk of Mercury spillage



Packaged separately: Digital Thermometer + Instruction Sheet* + Plastic Sleeve

*English/Spanish



Celcius



Dual Fahrenheit/Celcius

EASY TO USE:

1. Make sure the forehead is clean and dry.
2. Firmly apply onto the middle of the forehead, holding it at both ends, without touching numbers.
3. Wait until colors stop changing, usually 15-20 seconds.
4. READ THE GREEN COLOR ONLY. Disregard Blue and Tan colors.



What are Liquid crystals? They are the most thermally sensitive materials known, possessing a unique state of matter: the optical properties of both liquids and crystals. The colorful diffracting liquid crystals are cholesteric esters which change colors when their molecules, which are in a spiral structural form, are caused to change due to temperature variations. Such molecular movement results in visible color shifts which are evident to the eye.

Research has shown that forehead temperatures closely follow internal, or "core" temperature movements. The central forehead is notably free of fat or obscuring and insulating tissue masses. Digital thermometers when placed on the forehead correspond directly to core temperature variations. Measuring from the surface allows you to quickly and easily determine any temperature trends.



5860-C Hollister Avenue
Santa Barbara, CA 93117 U.S.A.

Telephone: 805 967-1153
FAX: 805 967-1295

Website: www.tecfe.com
email: tecfe@tecfe.com

Silicone Ear Putty® Plugs



Designed to help protect the user's ears against damaging noise levels, prevent or eliminate water retention in the ear canal, and remove excess ear-wax buildup.

- Pliable and moldable
- Silicone, a polymer that is hypoallergenic and water repellent
- Easily inserted and removed with no residue or "clean-up"
- Packed and stored in plastic storage containers for reuse
- Two plugs per plastic container



SB-30002
small plastic carrying case
2 plugs/case



SB-30024
small plastic carrying case
Packaged in shrink-wrap
24 cases per display box
2 plugs/case



SB-30108
small plastic carrying case
8 plugs on a display card



CE



Provita Smoke Hood

Provides 20 vital minutes of life-saving evacuation time.



**Rubber seal at neck
One size fits all**

Proven to protect from smoke and 98% of toxins created by fire, including:

**Chlorine | Ammonia | Acrolein
Hydrogen chloride | Hydrogen sulfide**

**Lightweight and Compact
Wt. 6 oz
8" x 6" x 1" package size
Vacuum sealed**



**Gas-impermeable charcoal filter
Transparent, heat-resistant Kapton®**

"80% of those who die do so following incapacitation through breathing in smoke and toxic fumes during their attempts to escape, rather than from the flames from the fire itself"

- Parliamentary Advisory Council for Transport Safety

"An unscheduled landing of a commercial aircraft on average more than once a week" in the United States due to smoke and/or fire situations. Survival in a critical fire situation has depended until now on getting out fast."

- FAA Statistics report



1. Smoke Hood easily comes out of its 8"x6"x1" vacuum sealed bag — ready for use in seconds.



2. There is no front or back. The Smoke Hood can be put on quickly for panic situations.



3. The rubber seal easily slips over your head and seals — not allowing any smoke through.



4. The Smoke Hood provides 360 Degree vision and 20 vital minutes to escape a smoke filled room.



Partial List of Corporate Customers

Abbot Laboratories

AirFlite

BAE Systems

Dassault Falcon Jet

Dow Corning

Dow Chemical

Eli Lilly

Exxon Mobil

Gulfstream Aerospace

Hewlett-Packard

PEPSICO Flight Operations

PMI Global Service, Phillip

Morris



5860-C Hollister Avenue
Santa Barbara, CA 93117 U.S.A.

Telephone: 805 967-1153
FAX: 805 967-1295

Website: www.tecfe.com
email: tecfe@tecfe.com

Readers: Lighted, Bifocal, and Low Cost

LightSpecs Readers, lighted reading glasses



Liberty Black

1010101-150 +1.50 Diopter
1010101-200 +2.00 Diopter
1010101-250 +2.50 Diopter



Liberty Tortoise

1010028-150 +1.50 Diopter
1010028-200 +2.00 Diopter
1010028-250 +2.50 Diopter

Private Eye Bifocal Readers



Norah

PE222-100 +1.00 Diopter
PE222-125 +1.25 Diopter
PE222-150 +1.50 Diopter
PE222-175 +1.75 Diopter



Thom

PE221-100 +1.00 Diopter
PE221-125 +1.25 Diopter
PE221-150 +1.50 Diopter
PE221-175 +1.75 Diopter

Low Cost Clear Acrylic Readers



25100 +1.00 Diopter
25125 +1.25 Diopter
25150 +1.50 Diopter
25175 +1.75 Diopter
25200 +2.00 Diopter
25225 +2.25 Diopter
25250 +2.50 Diopter

25275 +2.75 Diopter
25300 +3.00 Diopter
25325 +3.25 Diopter
25350 +3.50 Diopter
25375 +3.75 Diopter
25400 +4.00 Diopter

