



Precision Ophthalmic Products



Tecfen Medical's ophthalmic range features our exclusive line of products as well as some of the industry's most recognizable brands that further enhance our ability to bring the quality and service that our customers have come to expect.

Tecfen Medical, an EN ISO 13485:2012 and ISO 9001:2008 certified company, strives to provide high quality medical disposable products to doctors, clinics and hospitals worldwide and is committed to building long lasting business relationships by ensuring customer satisfaction from beginning to end.



Tecfen Medical
5385 Hollister Avenue
Santa Barbara, CA 93111 U.S.A.

T: +1 805 967 1153
F: +1 805 967 1295
tecfen@tecfen.com
www.tecfenmedical.com

Rev 08.2015

2015 Ophthalmic Products Catalog

Ophthalmic Surgical Products

MICROKERATOME BLADES

Tecfen Premium Microkeratome Blades 4

OPHTHALMIC KNIVES & BLADES

Ophthalmic Knives & Blades 5, 6

PVA & CELLULOSE PRODUCTS

PVA Eye Spears, Instrument Wipes 7

Cellulose Eye Spears 7

TREPHINE BLADES

Corneal Punch Systems & Components 8

Long Trephines 9

Non-Vacuum & Vacuum

Trephine Punches For Donor 10

Vacuum Trephines For Recipient 11

OPHTHALMIC SURGERY DRAPES

Ophthalmic Surgery Drapes 12, 13, 14

OPHTHALMIC CANNULAS

Peribulbar and Retrobulbar Needles 15

Sub Tenon Needles 16

Anterior Chamber Cannulas 16, 17, 18

Anterior Chamber Cannulas (Thin Wall) 19

I/A Cannulas and Cortex Removal 20

J Shaped Cannulas 20

Irrigating Cystotomes 21

Capsule Polishers 21

Nucleus Removal, Irrigating,
Hydrodissection and Hydrodelineation 22

Lacrimal Products and
Miscellaneous Instruments 22, 23

Chamber Maintainers and
Retinal Cannulas 23, 24

Lasik Cannulas 24

Post-Op Sunglasses, Kits & Eyeshields

SOLARSHIELD® POST CATARACT SUNGLASSES & KITS

SolarShield® Fits Over™ Sunglasses 25

Post Cataract Kits 26

SOLARCOMFORT® POST REFRACTIVE SUNGLASSES & KITS

SolarComfort® Sunglasses 27

Post Refractive Kits 28

DUAL EYESHIELDS, GOGGLES & SINGLE EYESHIELDS

Encore® Dual Eyeshield 29

Encore® Goggle Eyeshield 29

Encore® Single Eyeshield 30

Encore® Two-Piece Eyeshield 30

Dry Eye Products

MOISTURE RETENTION CHAMBER

Encore® Moisture Retention Chamber 31

DIAGNOSTIC STRIPS

Diagnostic Strips 31

Tecfen Premium Microkeratome Blades

Provide a sharp and consistent blade edge

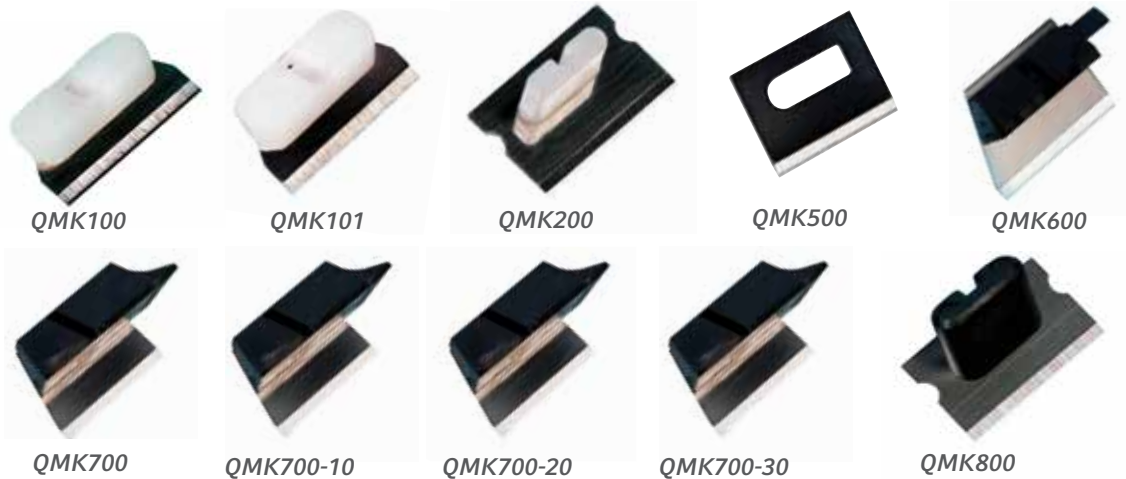

Our exclusive line of premium blades offers the highest standard of quality and superior cutting edge in the industry today. You can count on them to provide consistent sharpness every time.

- All blades available in +10, Plano, -10, -20, -30, -40 laser calibrated sizes for precision flap management.

Tecfen Premium Microkeratome Blades

PRODUCT NO.	DESCRIPTION	QTY PER BOX
QMK100	Bausch & Lomb™ Hansatome System Compatible	10/box
QMK101	Zyoptix™ XP™ System Compatible	10/box
QMK200	Moria™ LSK-One System Compatible	10/box
QMK500	Chiron™ ACS System Compatible	10/box
QMK600	Moria™ CB System Compatible	10/box
QMK700	Moria™ M2™ System Compatible	10/box
QMK700-10	Moria™ M2™ System Compatible (-10 Calibrated Blade)	10/box
QMK700-20	Moria™ M2™ System Compatible (-20 Calibrated Blade)	10/box
QMK700-30	Moria™ M2™ System Compatible (-30 Calibrated Blade)	10/box
QMK800	Nidek™ System Compatible	10/box

Ophthalmic Knives and Blades

Precision instruments available in a range of popular blade sizes and geometries



Tecfen Ophthalmic Knives provide a "Controlled Cut", providing the surgeon with the perfect combination of sharpness and control. This gives the surgeon the optimal amount of tactile feedback necessary when performing procedures.

THE FOLLOWING IS A COLLECTION OF OUR MOST POPULAR KNIVES.
OTHER SIZES AND MODELS AVAILABLE BY REQUEST.

Stab Knives



PRODUCT NO.	DESCRIPTION	QTY PER BOX
QKN1501	15 Degree Stab Knife	6/Box
QKN1531	15 Degree Stab Knife 3 mm Restricted Depth	6/Box
QKN1551	15 Degree Stab Knife 5mm Restricted Depth	6/Box

PRODUCT NO.	DESCRIPTION	QTY PER BOX
QKN1552	15 Degree Threaded Tip 5 mm Restricted Depth	6/Box
QKN3001	30 Degree Stab Knife	6/Box
QKN4501	45 Degree Stab Knife	6/Box

Slit Knives



PRODUCT NO.	DESCRIPTION	QTY PER BOX
QKN1863	1.8 mm Slit Knife Angled	6/Box
QKN2261	2.2 mm Slit Knife Angled	6/Box
QKN2461	2.4 mm Slit Knife Angled	6/Box
QKN2561	2.5 mm Slit Knife Angled	6/Box
QKN2761	2.75 mm Slit Knife Angled	6/Box

PRODUCT NO.	DESCRIPTION	QTY PER BOX
QKN2731	2.75 mm Slit Knife, Double Bevel, Angled	6/Box
QKN2808	2.8 mm Slit Knife Angled	6/Box
QKN2961	3.0 mm Slit Knife Angled	6/Box
QKN3261	3.2 mm Slit Knife Angled	6/Box

Ophthalmic Knives and Blades

Precision instruments available in a range of popular blade sizes and geometries

Clear Corneal Knives



PRODUCT NO.	DESCRIPTION	QTY PER BOX
QKN2835	2.85 mm Clear Corneal Knife, Side Cutting, Parallel Sides	6/box

Crescent Knives



PRODUCT NO.	DESCRIPTION	QTY PER BOX
QKN1000	2.0 mm Crescent Knife Straight Bevel Up	6/box
QKN1010	2.0 mm Crescent Knife Angled Bevel Up	6/box

MVR Knives



PRODUCT NO.	DESCRIPTION	QTY PER BOX
QKN2314	19G (1.4 mm Blade Width) MVR Knife Straight	6/box
QKN2312	20G (1.2 mm Blade Width) MVR Knife Straight	6/box
QKN2308	23G (0.8 mm Blade Width) MVR Knife Straight	6/box

PVA & Cellulose Sponge Eye Products

Specifically designed for Lasik and other delicate procedures



PVA, and Cellulose Eye Spears are sterile, lint-free and highly absorbent

Also available in non-sterile, bulk



PVA Spears, Instrument Wipes, Corneal Light Shields, etc.

PRODUCT NO.	DESCRIPTION	QTY PER BOX/BAG
QPV091A	5 Spears/foil, 2 foils/tyvek, 20 tyveks/box	200 Spears/box
QPV091N	5 Spears/foil, 25 foils/box	125 Spears/box
QPV091D	5 Spears/foil, 100 foils/bag	500 Spears/bag
QPV091J	5 Spears/foil, 500 foils/bag	2500 Spears/bag
QPV40406N	10 Sterile Spear Tips/foil, 25 foils/box	250 Spear tips/box
QPV90910	Instrument Wipes 1.0mm	20/box
QPV40420	Corneal Light Shield 7.0mm	20/box
QPV40430	Eye Drain (80cc capacity): 1/pack	20 packs/box = 20 drains/box



Cellulose Eye Spears

PRODUCT NO.	DESCRIPTION	QTY PER BOX
QCE092A	10 Spears/glassine, 1 Glassine/tyvek, 20 tyveks/box	200 Spears/box



Trephine Blades

Tecfen Medical offers a comprehensive selection of corneal trephine blades and tissue punches featuring:

- Long styles
- Compatible with most punch systems
- Consistent results
- Range 4.00 to 18.00mm diameter
- Eye bank sizes available



Corneal Punch System & Components

PRODUCT NO.	DESCRIPTION	QTY PER BOX
QTR330010	Corneal Punch System Complete (Includes 7 – 9.0mm Punch Piston, Piston Holder & Base Plate)	1/Box
QTR330005	5-7.0mm Punch Piston	1/Box
QTR330007	7-9.0mm Punch Piston	1/Box
QTR330009	9-11.0mm Punch Piston	1/Box
QTR330001	Disposable Corneal Block (sterile)	1/Box



Trephine Blades

Long Trephines (For Donor or Recipient)



PRODUCT NO.	DESCRIPTION	QTY PER BOX
QTR330250	2.50mm Diameter	1/Box
QTR330300	3.00mm Diameter	1/Box
QTR330350	3.50mm Diameter	1/Box
QTR330400	4.00mm Diameter	1/Box
QTR330450	4.50mm Diameter	1/Box
QTR330500	5.00mm Diameter	1/Box
QTR330550	5.50mm Diameter	1/Box
QTR330575	5.75mm Diameter	1/Box
QTR330600	6.00mm Diameter	1/Box
QTR330625	6.25mm Diameter	1/Box
QTR330650	6.50mm Diameter	1/Box
QTR330675	6.75mm Diameter	1/Box
QTR330700	7.00mm Diameter	1/Box
QTR330725	7.25mm Diameter	1/Box
QTR330750	7.50mm Diameter	1/Box
QTR330775	7.75mm Diameter	1/Box
QTR330785	7.85mm Diameter	1/Box
QTR330800	8.00mm Diameter	1/Box
QTR330825	8.25mm Diameter	1/Box
QTR330850	8.50mm Diameter	1/Box

PRODUCT NO.	DESCRIPTION	QTY PER BOX
QTR330875	8.75mm Diameter	1/Box
QTR330900	9.00mm Diameter	1/Box
QTR330950	9.50mm Diameter	1/Box
QTR331000	10.00mm Diameter	1/Box
QTR331050	10.50mm Diameter	1/Box
QTR331100	11.00mm Diameter	1/Box
QTR331150	11.50mm Diameter	1/Box
QTR331200	12.00mm Diameter	1/Box
QTR331250	12.50mm Diameter	1/Box
QTR331300	13.00mm Diameter	1/Box
QTR331350	13.50mm Diameter	1/Box
QTR331400	14.00mm Diameter	1/Box
QTR331450	14.50mm Diameter	1/Box
QTR331500	15.00mm Diameter	1/Box
QTR331550	15.50mm Diameter	1/Box
QTR331600	16.00mm Diameter	1/Box
QTR331650	16.50mm Diameter	1/Box
QTR331700	17.00mm Diameter	1/Box
QTR331800	18.00mm Diameter	1/Box

Trephine Blades



Non-Vacuum Trephine Punches (For Donor)

PRODUCT NO.	DESCRIPTION	QTY PER BOX
QTR340600	6.00mm Diameter	1/Box
QTR340625	6.25mm Diameter	1/Box
QTR340650	6.50mm Diameter	1/Box
QTR340675	6.75mm Diameter	1/Box
QTR340700	7.00mm Diameter	1/Box
QTR340725	7.25mm Diameter	1/Box
QTR340750	7.50mm Diameter	1/Box
QTR340775	7.75mm Diameter	1/Box

PRODUCT NO.	DESCRIPTION	QTY PER BOX
QTR340800	8.00mm Diameter	1/Box
QTR340825	8.25mm Diameter	1/Box
QTR340850	8.50mm Diameter	1/Box
QTR340875	8.75mm Diameter	1/Box
QTR340900	9.00mm Diameter	1/Box
QTR340925	9.25mm Diameter	1/Box
QTR340950	9.50mm Diameter	1/Box

Vacuum Trephine Punches (For Donor)

PRODUCT NO.	DESCRIPTION	QTY PER BOX
QTR360600	6.00mm Diameter	1/Box
QTR360625	6.25mm Diameter	1/Box
QTR360650	6.50mm Diameter	1/Box
QTR360675	6.75mm Diameter	1/Box
QTR360700	7.00mm Diameter	1/Box
QTR360725	7.25mm Diameter	1/Box
QTR360750	7.50mm Diameter	1/Box
QTR360775	7.75mm Diameter	1/Box
QTR360785	7.85mm Diameter	1/Box
QTR360800	8.00mm Diameter	1/Box
QTR360825	8.25mm Diameter	1/Box
QTR360850	8.50mm Diameter	1/Box
QTR360875	8.75mm Diameter	1/Box
QTR360900	9.00mm Diameter	1/Box
QTR360925	9.25mm Diameter	1/Box
QTR360950	9.50mm Diameter	1/Box



Trephine Blades

Radial Vacuum Trephines (For Recipient)

PRODUCT NO.	DESCRIPTION	QTY PER BOX
QTR370600	6.00mm Diameter	1/Box
QTR370650	6.50mm Diameter	1/Box
QTR370700	7.00mm Diameter	1/Box
QTR370725	7.25mm Diameter	1/Box
QTR370750	7.50mm Diameter	1/Box
QTR370775	7.75mm Diameter	1/Box

PRODUCT NO.	DESCRIPTION	QTY PER BOX
QTR370800	8.00mm Diameter	1/Box
QTR370825	8.25mm Diameter	1/Box
QTR370850	8.50mm Diameter	1/Box
QTR370875	8.75mm Diameter	1/Box
QTR370900	9.00mm Diameter	1/Box



Ophthalmic Surgery Drapes

Patient drapes specifically designed for ophthalmic procedures

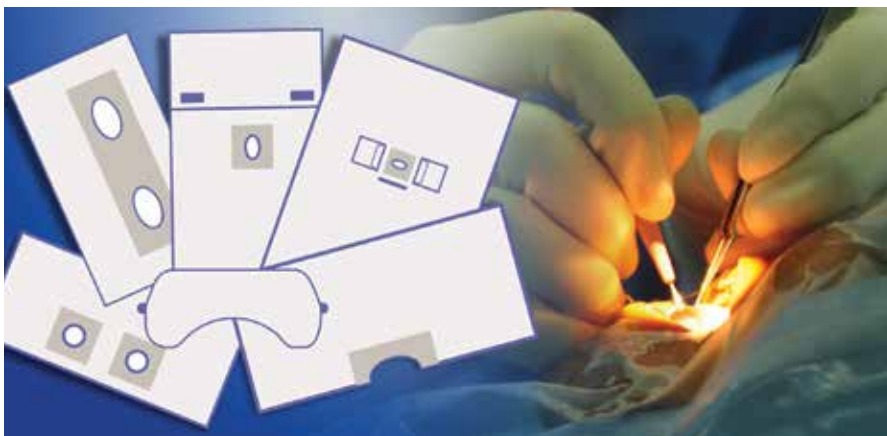

Our ophthalmic surgical drapes are manufactured to the highest standards using latex-free materials in the USA. The matte finish on the drapes produces little glare during surgery, while the adhesive reliably secures the drape to the patient's skin. The free-flowing design allows the drape to contour to the patient's form, allowing for an easier surgical process.

OUR DRAPES ARE NOT AVAILABLE FOR ALL COUNTRIES, PLEASE INQUIRE

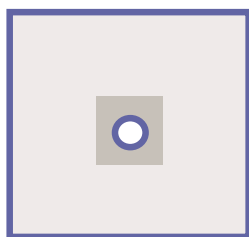

PRODUCT NO	DESCRIPTION	SIZE	TYPE
D1020	Full Plastic Drape	40cm X 40cm	Aperture 6cm Dia.

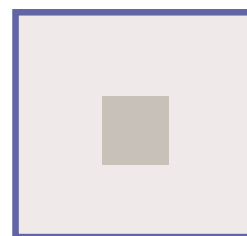

PRODUCT NO	DESCRIPTION	SIZE	TYPE
D1021	Full Plastic Drape	40cm X 40cm	Incise

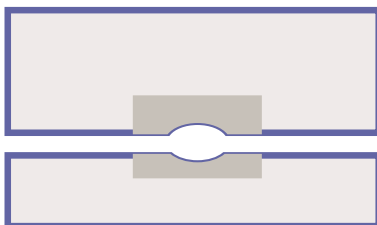

PRODUCT NO	DESCRIPTION	SIZE	TYPE
D1022	Refractive, Two-piece	40cm X 27cm	Aperture 3.8cm X 2.5cm

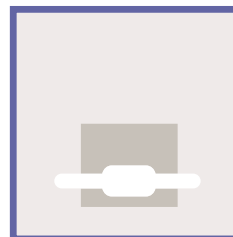

PRODUCT NO	DESCRIPTION	SIZE	TYPE
D1122	Refractive One-Piece	40cm X 27cm	Aperture 3.8cm X 2.54cm

PRECISION OPHTHALMIC PRODUCTS

Ophthalmic Surgery Drapes

Patient drapes specifically designed for ophthalmic procedures

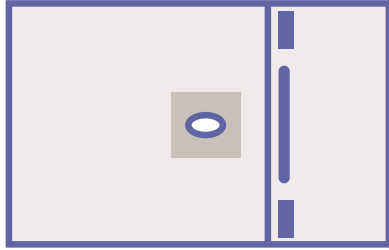

PRODUCT NO	DESCRIPTION	SIZE	TYPE
D1024A	Aperture Pouch	48cm X 38cm	Aperture 5cm X 3cm

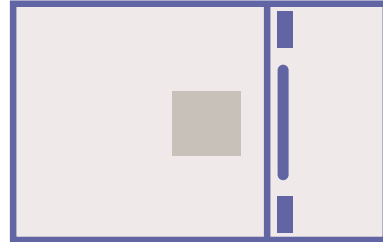

PRODUCT NO	DESCRIPTION	SIZE	TYPE
D1025	Incise Pouch	48cm X 38cm	Incise

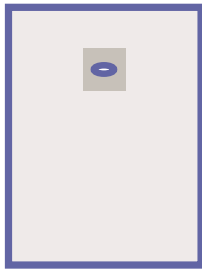

PRODUCT NO	DESCRIPTION	SIZE	TYPE
D1030	Aperture	83cm X 129cm	Aperture 7cm X 5cm

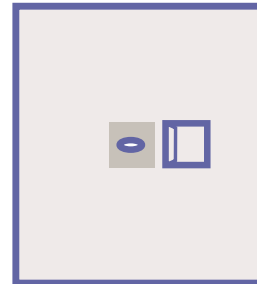

PRODUCT NO	DESCRIPTION	SIZE	TYPE
D1031	Aperture Pouch	121cm X 129cm	Aperture 7cm X 5cm

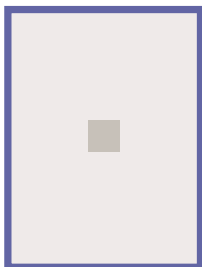

PRODUCT NO	DESCRIPTION	SIZE	TYPE
D1060	Incise	121cm X 129cm	Incise

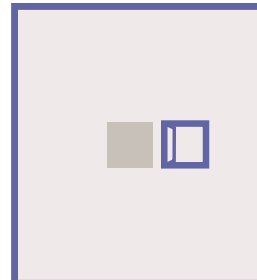

PRODUCT NO	DESCRIPTION	SIZE	TYPE
D1061	Incise Pouch	121cm X 129cm	Incise

Ophthalmic Surgery Drapes

Patient drapes specifically designed for ophthalmic procedures

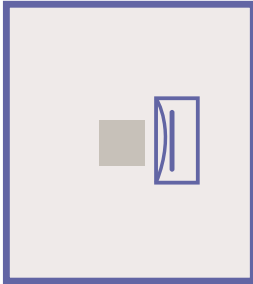

PRODUCT NO	DESCRIPTION	SIZE	TYPE
D1062	Irrigation Pouch	121cm X 139cm	Incise

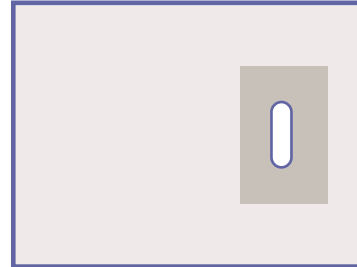

PRODUCT NO	DESCRIPTION	SIZE	TYPE
D2043	Strabismus	101cm X 121cm	Aperture 13cm X 4cm

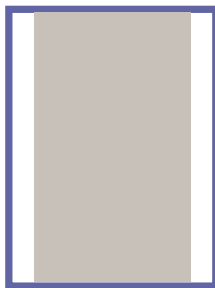

PRODUCT NO	DESCRIPTION	SIZE	TYPE
D1035	Incise	16cm X 19cm	Incise



PRODUCT NO	DESCRIPTION	SIZE	TYPE
D2021	Irrigation Pouch	21cm X 27cm	Incise

Ophthalmic Cannulas

Full range of single use cannula instruments

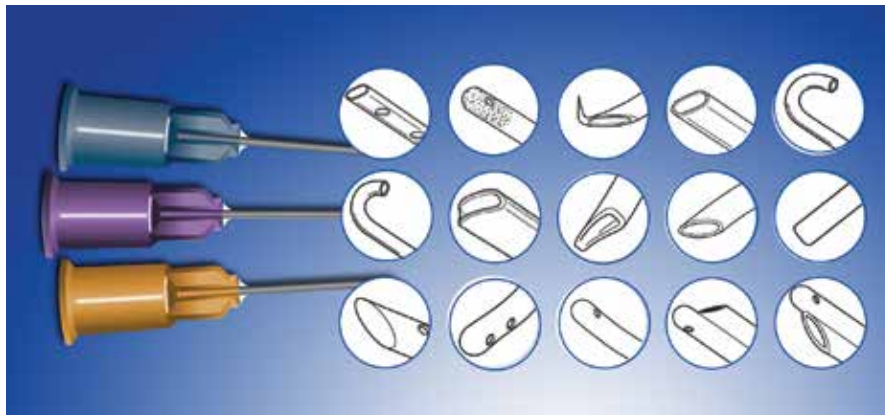

Disposable ophthalmic cannulas for cataract, refractive, lacrimal and vitreoretinal surgery.

Count on the trusted portfolio of disposable instruments for all your surgical needs.

Peribulbar Needles



PRODUCT NO.	DESCRIPTION	QTY PER BOX
TE-0001C	(Atkinson) 27g X 22mm - 7/8"	10/Box
TE-0001F	(Atkinson) 27g X 32mm - 1 1/4"	10/Box
TE-0003A	(Atkinson) 25g X 16mm - 5/8"	10/Box
TE-0003C	(Atkinson) 25g X 22mm - 7/8"	10/Box
TE-0003F	(Atkinson) 25g X 32mm - 1 1/4"	10/Box
TE-0004A	(Atkinson) 23g X 16mm - 5/8"	10/Box
TE-0004C	(Atkinson) 23g X 22mm - 7/8"	10/Box

PRODUCT NO.	DESCRIPTION	QTY PER BOX
TE-0004F	(Atkinson) 23g X 32mm - 1 1/4"	10/Box
TE-0011	(Non Atkinson) 27g X 38mm - 1 1/2"	10/Box
TE-0012	(Non Atkinson) 25g X 22mm - 7/8"	10/Box
TE-0013	(Non Atkinson) 23g X 16mm - 5/8"	10/Box
TE-0014	(Non Atkinson) 25g X 16mm - 5/8"	10/Box
TE-0015	(Non Atkinson) 27g X 16mm - 5/8"	10/Box
TE-0016	(Non Atkinson) 30g X 16mm - 5/8"	10/Box

Retrobulbar Needles

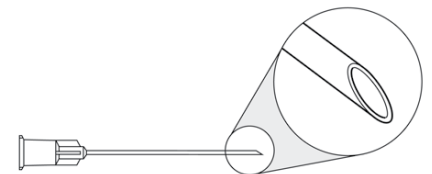

PRODUCT NO.	DESCRIPTION	QTY PER BOX
TE-0001H	(Atkinson) 27g X 38mm - 1 1/2"	10/Box
TE-0003H	(Atkinson) 25g X 38mm - 1 1/2"	10/Box
TE-0004H	(Atkinson) 23g X 38mm - 1 1/2"	10/Box

PRODUCT NO.	DESCRIPTION	QTY PER BOX
TE-0008	(Non Atkinson) 25g X 38mm - 1 1/2"	10/Box
TE-0009	(Non Atkinson) 26g X 38mm - 1 1/2"	10/Box
TE-0010	(Non Atkinson) 27g X 38mm - 1 1/2"	10/Box

Ophthalmic Cannulas

Full range of single use cannula instruments

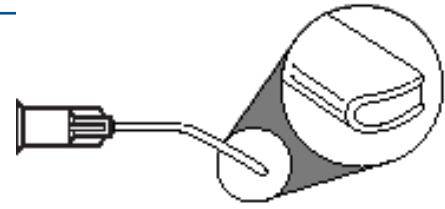

Sub Tenon Needles

PRODUCT NO.	DESCRIPTION	QTY PER BOX
TE-0020	19g X 22mm X 1" curved, flattened tip	10/Box
TE-0021	21g X 22mm X 7/8" curved, tri port	10/Box
TE-0022	21g X 22mm X 7/8" 7mm angled tip, tri port	10/Box
TE-0023	19g X 25mm X 1" curved, tri port	10/Box
TE-0024	19g X 25mm X 1" 7mm angled tip, tri port	10/Box
TE-0027S	Rous 25g X 16mm X 5/8" Extra Sharp curved, bevel down	10/Box

Anterior Chamber Cannulas

Anterior Chamber Cannulas (also known as: Air Injection, Rycroft, and Viscoelastic Cannulas) The most popular are marked with an "*". To use the chart, select the desired gauge and length of angled tip, then record that catalog number. (For example, a 27g cannula with a 6mm angled tip would be catalog number 1001-6). The drawings at the top of each column depict actual length of the angled tip.

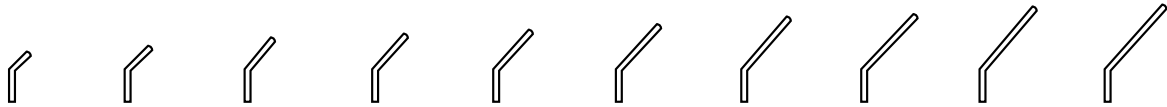

	3mm	4mm	5mm	6mm	7mm	8mm	9mm	10mm	11mm	12mm
30g	1000-3	1000-4*	1000-5	1000-6*	1000-7	1000-8	1000-9	1000-10	1000-11	1000-12
27g	1001-3	1001-4*	1001-5	1001-6*	1001-7	1001-8*	1001-9	1001-10	1001-11*	1001-12
25g	1003-3	1003-4	1003-5	1003-6*	1003-7	1003-8*	1003-9	1003-10	1003-11	1003-12
23g	1004-3	1004-4	1004-5	1004-6*	1004-7	1004-8*	1004-9	1004-10	1004-11	1004-12
21g	1006-3	1006-4	1006-5	1006-6	1006-7	1006-8	1006-9	1006-10	1006-11	1006-12
20g	1007-3	1007-*	1007-5	1007-6	1007-7	1007-8	1007-9	1007-10	1007-11	1007-12
19g	1008-3	1008-4	1008-5	1008-6	1008-7	1008-8	1008-9	1008-10	1008-11	1008-12

NOTE: Anterior Chamber Cannulas have the following specifications:

- angle - 32°
- length - 22mm (7/8") PLEASE NOTE: 19g
- tumble polished tips for smoother radii

Ophthalmic Cannulas

Full range of single use cannula instruments

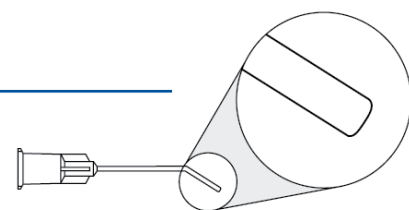

Anterior Chamber Cannulas

PRODUCT NO.	DESCRIPTION	QTY PER BOX
TE-1000-3	30g, 3mm bend	10/Box
TE-1000-4	30g, 4mm bend	10/Box
TE-1000-5	30g, 5mm bend	10/Box
TE-1000-6	30g, 6mm bend	10/Box
TE-1000-7	30g, 7mm bend	10/Box
TE-1000-8	30g, 8mm bend	10/Box
TE-1000-9	30g, 9mm bend	10/Box
TE-1000-10	30g, 10mm bend	10/Box
TE-1000-11	30g, 11mm bend	10/Box
TE-1000-12	30g, 12mm bend	10/Box
TE-1001-3	27g, 3mm bend	10/Box
TE-1001-4	27g, 4mm bend	10/Box
TE-1001-4	27g, 4mm bend	10/Box
TE-1001-5	27g, 5mm bend	10/Box
TE-1001-6	27g, 6mm bend	10/Box
TE-1001-7	27g, 7mm bend	10/Box
TE-1001-8	27g, 8mm bend	10/Box
TE-1001-9	27g, 9mm bend	10/Box
TE-1001-10	27g, 10mm bend	10/Box
TE-1001-11	27g, 11mm bend	10/Box
TE-1001-12	27g, 12mm bend	10/Box
TE-1003-3	25g, 3mm bend	10/Box
TE-1003-4	25g, 4mm bend	10/Box
TE-1003-5	25g, 5mm bend	10/Box
TE-1003-6	25g, 6mm bend	10/Box
TE-1003-7	25g, 7mm bend	10/Box
TE-1003-8	25g, 8mm bend	10/Box
TE-1003-9	25g, 9mm bend	10/Box

PRODUCT NO.	DESCRIPTION	QTY PER BOX
TE-1003-10	25g, 10mm bend	10/Box
TE-1003-11	25g, 11mm bend	10/Box
TE-1003-9	25g, 9mm bend	10/Box
TE-1003-10	25g, 10mm bend	10/Box
TE-1003-11	25g, 11mm bend	10/Box
TE-1003-12	25g, 12mm bend	10/Box
TE-1004-3	23g, 3mm bend	10/Box
TE-1004-4	23g, 4mm bend	10/Box
TE-1004-5	23g, 5mm bend	10/Box
TE-1004-6	23g, 6mm bend	10/Box
TE-1004-7	23g, 7mm bend	10/Box
TE-1004-8	23g, 8mm bend	10/Box
TE-1004-9	23g, 9mm bend	10/Box
TE-1004-10	23g, 10mm bend	10/Box
TE-1004-11	23g, 11mm bend	10/Box
TE-1004-12	23g, 12mm bend	10/Box
TE-1003-9	25g, 9mm bend	10/Box
TE-1003-10	25g, 10mm bend	10/Box
TE-1003-11	25g, 11mm bend	10/Box
TE-1003-12	25g, 12mm bend	10/Box
TE-1004-3	23g, 3mm bend	10/Box
TE-1004-4	23g, 4mm bend	10/Box
TE-1004-5	23g, 5mm bend	10/Box
TE-1004-6	23g, 6mm bend	10/Box
TE-1004-7	23g, 7mm bend	10/Box
TE-1004-8	23g, 8mm bend	10/Box
TE-1004-9	23g, 9mm bend	10/Box
TE-1004-10	23g, 10mm bend	10/Box

Ophthalmic Cannulas

Full range of single use cannula instruments

Anterior Chamber Cannulas

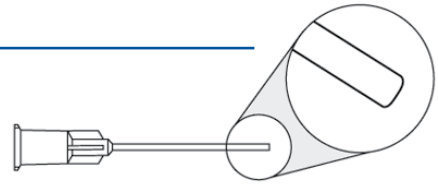

PRODUCT NO.	DESCRIPTION	QTY PER BOX
TE-1004-11	23g, 11mm bend	10/Box
TE-1004-12	23g, 12mm bend	10/Box
TE-1006-3	21g, 3mm bend	10/Box
TE-1006-4	21g, 4mm bend	10/Box
TE-1006-5	21g, 5mm bend	10/Box
TE-1006-6	21g, 6mm bend	10/Box
TE-1006-7	21g, 7mm bend	10/Box
TE-1006-8	21g, 8mm bend	10/Box
TE-1006-9	21g, 9mm bend	10/Box
TE-1006-10	21g, 10mm bend	10/Box
TE-1006-11	21g, 11mm bend	10/Box
TE-1006-12	21g, 12mm bend	10/Box
TE-1007-3	20g, 3mm bend	10/Box
TE-1007-4	20g, 4mm bend	10/Box
TE-1007-5	20g, 5mm bend	10/Box
TE-1007-6	20g, 6mm bend	10/Box
TE-1007-7	20g, 7mm bend	10/Box
TE-1007-8	20g, 8mm bend	10/Box
TE-1007-9	20g, 9mm bend	10/Box
TE-1007-10	20g, 10mm bend	10/Box
TE-1007-11	20g, 11mm bend	10/Box
TE-1007-12	20g, 12mm bend	10/Box
TE-1008-3	19g, 3mm bend	10/Box
TE-1008-4	19g, 4mm bend	10/Box
TE-1008-5	19g, 5mm bend	10/Box

PRODUCT NO.	DESCRIPTION	QTY PER BOX
TE-1008-6	19g, 6mm bend	10/Box
TE-1008-7	19g, 7mm bend	10/Box
TE-1008-8	19g, 8mm bend	10/Box
TE-1008-9	19g, 9mm bend	10/Box
TE-1008-10	19g, 10mm bend	10/Box
TE-1008-11	19g, 11mm bend	10/Box
TE-1008-12	19g, 12mm bend	10/Box
TE-1100S	30g X 22mm (7/8"), straight	10/Box
TE-1100C	30g X 22mm (7/8"), curved	10/Box
TE-1101S	27g X 22mm (7/8"), straight	10/Box
TE-1101C	27g X 22mm(7/8"), curved	10/Box
TE-1103S	25g X 22mm(7/8"), straight	10/Box
TE-1103C	25g X 22mm (7/8"), curved	10/Box
TE-1104S	23g X 22mm (7/8"), straight	10/Box
TE-1104SL	23g X 32mm (1 1/4"), straight	10/Box
TE-1104C	23g X 22mm (7/8"), curved	10/Box
TE-1106S	21g X 22mm (7/8"), straight	10/Box
TE-1106C	21g X 22mm (7/8"), curved	10/Box
TE-1107S	20g X 25mm (1"), straight	10/Box
TE-1107C	20g X 25mm (1"), curved	10/Box
TE-1108S	19g X25 mm (1"), straight	10/Box
TE-1108C	19g X 25mm (1"), curved	10/Box
TE-1200	Viscoelastic Cannula 27g X 22mm (7/8"), formed	10/Box

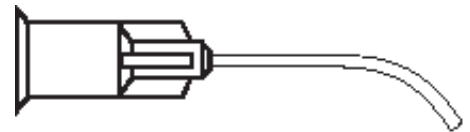

Ophthalmic Cannulas

Full range of single use cannula instruments

Thin Wall Anterior Chamber Cannulas (also known as: Air Injection, Rycroft, and Viscoelastic Cannulas) offer several advantages over regular wall cannulas.

ADVANTAGES TO THIN WALL CANNULAS

- The inside diameter is approximately 2 gauge sizes larger, therefore a 25 g. T.W. Lumen is approximately the same as the inside lumen on a 23g (see illustration)
- Viscous materials flow through the cannula with less effort
- Thin Wall Cannulas allow the advantages of a large bore through a smaller cannula

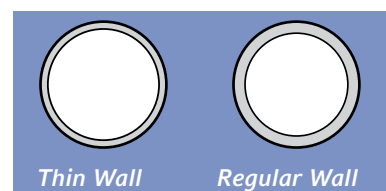

The most popular have been marked with an “*”. To use the chart, select the desired gauge and length of angled tip, then record that catalog number. (For example, a 25g thin wall cannula with a 6mm angled tip would be catalog number 2003-6). The drawings at the top of each column depict actual length of the angled tip.

	3mm	4mm	5mm	6mm	7mm	8mm	9mm	10mm	11mm	12mm
25gTW	2003-3	2003-4	2003-5	2003-6*	2003-7	2003-8*	2003-9	2003-10	2003-11	2003-12
23gTW	2004-3	2004-4	2004-5	2004-6*	2004-7	2004-8*	2004-9	2004-10	2004-11	2004-12

* Denotes most requested Thin Wall Anterior Chamber Cannulas:

Anterior Chamber Cannulas, Thin Wall

PRODUCT NO.	DESCRIPTION	QTY PER BOX	PRODUCT NO.	DESCRIPTION	QTY PER BOX
TE-2003-3	TW 25g, 3mm bend	10/Box	TE-2004-5	TW 23g, 5mm bend	10/Box
TE-2003-4	TW 25g, 4mm bend	10/Box	TE-2004-6	TW 23g, 6mm bend	10/Box
TE-2003-5	TW 25g, 5mm bend	10/Box	TE-2004-7	TW 23g, 7mm bend	10/Box
TE-2003-6	TW 25g, 6mm bend	10/Box	TE-2004-8	TW 23g, 8mm bend	10/Box
TE-2003-7	TW 25g, 7mm bend	10/Box	TE-2004-9	TW 23g, 9mm bend	10/Box
TE-2003-8	TW 25g, 8mm bend	10/Box	TE-2004-10	TW 23g, 10mm bend	10/Box
TE-2003-9	TW 25g, 9mm bend	10/Box	TE-2004-11	TW 23g, 11mm bend	10/Box
TE-2003-10	TW 25g, 10mm bend	10/Box	TE-2004-12	TW 23g, 10mm bend	10/Box
TE-2003-11	TW 25g, 11mm bend	10/Box	TE-2103S	TW 23g, straight	10/Box
TE-2003-12	TW 25g, 12mm bend	10/Box	TE-2103C	TW 23g, curved	10/Box
TE-2004-3	TW 23g, 3mm bend	10/Box	TE-2104S	TW 23g, straight	10/Box
TE-2004-4	TW 23g, 4mm bend	10/Box	TE-2104C	TW 23g, curved	10/Box

Ophthalmic Cannulas

Full range of single use cannula instruments

I/A Cannulas and Cortex Removal

PRODUCT NO.	DESCRIPTION	QTY PER BOX
TE-3000	Dbl. I/A Cannula 21g X 21g, side port	10/Box
TE-3000J	"J" Shaped Dbl. I/A Cannula 23g X 25g X 1 1/2"	10/Box
TE-3001	Dbl. I/A Cannula 21g X 21g, open end	10/Box
TE-3002	Dbl. I/A Cannula 21g X 19g, open end	10/Box
TE-3003	Dbl. Barrel Cannula (Simcoe) 23g X 23g	10/Box
TE-3003R	Dbl. Barrel Cannula (Simcoe) 23g X 23g reusable	1/Box
TE-3004	Rvrs. Dbl. Barrel Cannula (Simcoe) 23g X 23g	10/Box
TE-3005	Cortex Extractor (Simcoe) 23g X 13mm	10/Box
TE-3006	Cortex Extractor (Simcoe) 23g X 22mm	10/Box
TE-3007	Cortex Extractor (Charleux) 23g X 1 1/2"	10/Box

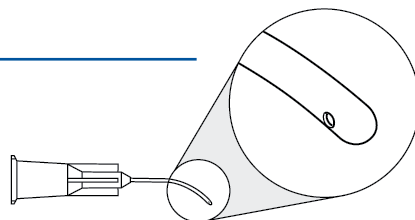

J Shaped Cannulas

PRODUCT NO.	DESCRIPTION	QTY PER BOX
TE-4000	"J" Shape Cannula 30g	10/Box
TE-4001	"J" Shape Cannula 27g	10/Box
TE-4003	"J" Shape Cannula 25g	10/Box
TE-4003C	Viscoexpression Cannula [Corydon] 25g	10/Box
TE-4003-10	"J" Shape Cannula 25g X 10mm bend	10/Box
TE-4003-17L	[Binkhorst] Cannula 25g, left	10/Box
TE-4003-17R	[Binkhorst] Cannula 25g, right	10/Box
TE-4003M	Micro "J" Shaped Cannula [Hessburg] 25g	10/Box
TE-4004	"J" Shape Cannula 23g	10/Box
TE-4004-10	"J" Shape Cannula 23g X 10mm bend	10/Box
TE-4006	"J" Shape Cannula 21g	10/Box

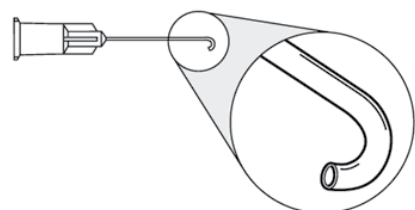

Ophthalmic Cannulas

Full range of single use cannula instruments

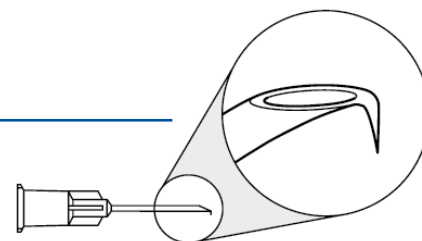

Irrigating Cystotomes

PRODUCT NO.	DESCRIPTION	QTY PER BOX
TE-5000AS	30g X 16mm (5/8"), straight	10/Box
TE-5001AS	27g X 16mm (5/8"), straight	10/Box
TE-5001BS	27g X 19mm (3/4"), straight	10/Box
TE-5003AS	25g X 16mm (5/8"), straight	10/Box
TE-5003CS	25g X 22mm (7/8"), straight	10/Box
TE-5004AS	23g X 16mm (5/8"), straight	10/Box
TE-5004BS	23g X 19mm (3/4"), straight	10/Box
TE-5000AF	30g X 16mm (5/8"), formed	10/Box
TE-5001AF	27g X 16mm (5/8"), formed	10/Box
TE-5001BF	27g X 19mm (3/4"), formed	10/Box
TE-5003AF	25g X 16mm (5/8"), formed	10/Box
TE-5003CF	25g X 22mm (7/8"), formed	10/Box
TE-5004AF	23g X 16mm (5/8"), formed	10/Box
TE-5004BF	23g X 19mm (3/4"), formed	10/Box
TE-5001AA	27g X 16mm (5/8"), angled	10/Box

PRODUCT NO.	DESCRIPTION	QTY PER BOX
TE-5003AA	25g X 16mm (5/8"), angled	10/Box
TE-5001AC	[Joyce] 27g X 16mm (5/8"), curved	10/Box
TE-5003AC	[Joyce] 25g X 16mm (5/8"), curved	10/Box
TE-5003ASC	25g X 16mm (5/8"), side cut	10/Box
TE-5001ASR	27g X 16mm (5/8"), small radius	10/Box
TE-5003ASR	25g X 16mm (5/8"), small radius	10/Box
TE-5003ARF	25g X 16mm (5/8"), reverse formed	10/Box
TE-5007	Capsulorhexis Cystotome 27g	10/Box
TE-5007S	Capsulorhexis Cystotome 27g, straight	10/Box
TE-5008	Capsulorhexis Cystotome 25g	10/Box
TE-5008S	Capsulorhexis Cystotome 25g, straight	10/Box
TE-5009	Capsulorhexis Cystotome 23g	10/Box
TE-5009S	Capsulorhexis Cystotome 23g, straight	10/Box
TE-5010	Irrigating Sharp Cystotome 22g	10/Box
TE-5011	Irrigating Double Sharp Cyst. 22g	10/Box

Capsule Polishers

PRODUCT NO.	DESCRIPTION	QTY PER BOX
TE-6000	Capsule Polisher 21g, sideport	10/Box
TE-6001	Capsule Polisher 23g, sideport	10/Box
TE-6002	Capsule Polisher 21g, open end	10/Box
TE-6003	Capsule Polisher 23g, open end	10/Box
TE-6005	Posterior Capsule Polisher 23g	10/Box
TE-6006	Flex. Tip Cap. Pol. 23gX7mm bend	10/Box
TE-6007	Flex. Tip Cap. Pol. 27gX7mm bend	10/Box
TE-6008	Flex. Tip Cap. Pol. 23gX9mm bend	10/Box

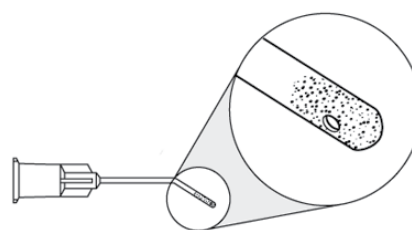

Ophthalmic Cannulas

Full range of single use cannula instruments

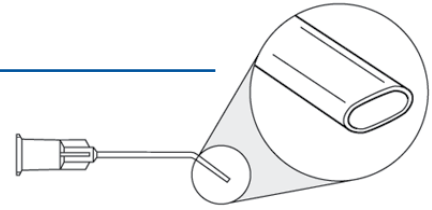

Nucleus Removal, Irrigating, Hydrodissection and Hydrodelineation

PRODUCT NO.	DESCRIPTION	QTY PER BOX
TE-7000	Irrigating Vectis 25g, 1 port	10/Box
TE-7001	Irrigating Vectis 25g, 1 port, 3mm	10/Box
TE-7002	Irrigating Vectis 25g, 2 port, 4mm	10/Box
TE-7003	Irrigating Vectis 25g, 3 port	10/Box
TE-7004	Anterior Washout Cannula 19g	10/Box
TE-7005	Hydrodissection Cannula 30g	10/Box
TE-7006	Hydrodissection Cannula 27g	10/Box
TE-7007	Hydrodissection Cannula 25g	10/Box
TE-7008	Hydrodissection Cannula 23g	10/Box
TE-7009A	"J" Shape Hydrodisc. Cannula 30g	10/Box
TE-7009B	"J" Shape Hydrodisc. Cannula 27g	10/Box
TE-7009C	"J" Shape Hydrodisc. Cannula 25g	10/Box
TE-7010	Hydrodelin. Ndl.[Kellan] 25g	10/Box

PRODUCT NO.	DESCRIPTION	QTY PER BOX
TE-7011	Hydrodelin. Ndl.[Kellan] 27g	10/Box
TE-7012	Hydrodissection Cannula [Kellan] 25g, curved	10/Box
TE-7013	Hydrodissection Cannula [Kellan] 27g, curved	10/Box
TE-7014	Nuc. Hydrolysis Ndl.[P. Koch] 25g, curved	10/Box
TE-7015	Nuc. Hydrodissector / Rotator [Sinsky] 25g.	10/Box
TE-7016	Cortical Cleaving Hydrodissector 27g	10/Box
TE-7017	Nucleus Hydrodissector 27g, curved	10/Box
TE-7018	Chang Hydrodissection Cannula 27g	10/Box
TE-7019	Akahoshi Hydrodissection Cannula 27g, curved end	10/Box

Lacrimal Products and Miscellaneous Instruments

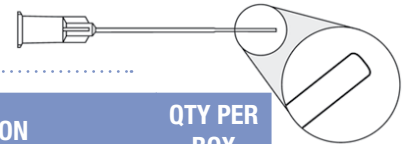

PRODUCT NO.	DESCRIPTION	QTY PER BOX
TE-8000	Lacrimal Cannula 25g, curved	10/Box
TE-8000-26	Lacrimal Cannula 26g, curved	10/Box
TE-8000S	Lacrimal Cann. 19g, tapered to 23g, straight	10/Box
TE-8001	Lacrimal Intubation Set	3/Box
TE-8002	Lac. Intb. Set w/retriever	3/Box
TE-8002WO	Lac. Intb. Set no/retriever	3/Box
TE-8003S	DCR Set, straight	3/Box
TE-8003A	DCR Set, angled	3/Box
TE-8200S	Micro Lens Hook [Sinsky] II str.	3/Box
TE-8200A	Micro Lens Hook [Sinsky] II ang.	3/Box
TE-8201	Lens Manipulating Hook [Fenz]	3/Box

PRODUCT NO.	DESCRIPTION	QTY PER BOX
TE-8202	Button Tip Manipulator, angled	3/Box
TE-8203	Lens Manipulator [Jaffe-Maltzman], ang.	3/Box
TE-8204	IOL Manipulating Hook [Lester], ang.	3/Box
TE-8205	Nucleus Rotator [Jaffe-Bechert], ang.	3/Box
TE-8206	Micro Iris Retractor [Pearce] angled	3/Box
TE-8207	Irrigating Dialer	10/Box
TE-8208	Nucleus Spatula [Pearce]	3/Box
TE-8209	Nucleus Chopper, angled	3/Box
TE-8400	Eye Speculum [Barraquer] adult	1/Box
TE-8401	Eye Speculum [Barraquer] child	1/Box
TE-8402	Eye Speculum [Kratz] adult	1/Box
TE-8500	Alpha-chymotrypsin	10/Box

Ophthalmic Cannulas

Full range of single use cannula instruments

Lacrimal Products and Miscellaneous Instruments (cont.)

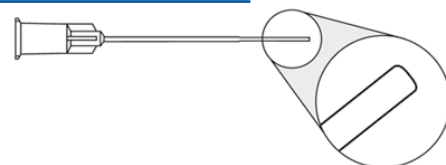

PRODUCT NO.	DESCRIPTION	QTY PER BOX
TE-8500S	Olive Tip Capsule Polisher 25g, curved	10/Box
TE-8501	Olive Tip Cannula 23g X 7/8", curved	10/Box
TE-8501S	Olive Tip Capsule Polisher 23g, curved	10/Box
TE-8503	Olive Tip Capsule Polisher 23g, angled	10/Box

PRODUCT NO.	DESCRIPTION	QTY PER BOX
TE-8600	Infusion Handle	10/Box
TE-8601	Male to Female Handpiece	10/Box
TE-8602	Double Male Handpiece	10/Box
TE-8603	Aspirating Handpiece w/finger hole	10/Box

Chamber Maintainers and Retinal Cannulas

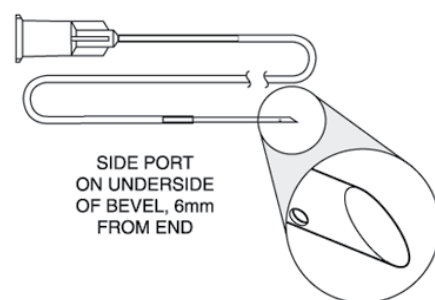

PRODUCT NO.	DESCRIPTION	QTY PER BOX
TE-9000	Chamber Maintainer 27g	10/Box
TE-9001	Chamber Maintainer 25g	10/Box
TE-9002	Chamber Maintainer 23g	10/Box
TE-9003	Chamber Maintainer 20g	10/Box
TE-9004	Chmb. Maint. w/serrated tip 25g	10/Box
TE-9005	Chmb. Maint. w/serrated tip 23g	10/Box
TE-9006	Chmb. Maint. w/serrated tip 20g	10/Box
TE-9007	Infusion Cannula 20g, 2.5mm tip	10/Box
TE-9008	Infusion Cannula 20g, 4mm tip	10/Box
TE-9009	Infusion Cannula 20g, 6mm tip	10/Box
TE-9010SB	Extru. Cann. 20g, straight, blunt	10/Box
TE-9010ST	Extru. Cann. 20g, straight, tapered	10/Box
TE-9010STS	Extru. Cann. w/sil.tub.20g,str., tprd	10/Box
TE-9010AT	Extru. Cann. 20g, angled, tapered	10/Box
TE-9010ATS	Extru. Cann. w/sil.tub.20g,ang., tprd	10/Box

PRODUCT NO.	DESCRIPTION	QTY PER BOX
TE-9011SB	Extru. Cann. 19g, straight, blunt	10/Box
TE-9011ST	Extru. Cann. 19g, straight, tapered	10/Box
TE-9011STS	Extru. Cann. w/sil.tub.19g,str., tprd	10/Box
TE-9011AT	Extru. Cann. 19g, angled, tapered	10/Box
TE-9011ATS	Extru. Cann. w/sil.tub.19g,ang., tprd	10/Box
TE-9012SB	Extru. Cann. 23g, straight, blunt	10/Box
TE-9020	High Viscosity Fluid Needle 16g	10/Box
TE-9021	Mem. Diss. [Kingham] 20gX25mm	10/Box
TE-9022	Subretinal Injector [Lambert] 20g. tprd	10/Box
TE-9023	Subretinal Injector [Landers] 20g. tprd	10/Box
TE-9025	Flute Needle [Charles] 19gX1"	10/Box
TE-9029	Membrane Micropick [Eaton] 20g, tprd	10/Box
TE-9030	Vitreoretinal Micropick 20g, tapered	10/Box
TE-9031	Vitreoretinal Micropick 23g, tapered	10/Box

Ophthalmic Cannulas

Full range of single use cannula instruments

Chamber Maintainers and Retinal Cannulas (continued)

PRODUCT NO.	DESCRIPTION	QTY PER BOX
TE-9032	Vitreoretinal Cann. [Vander] 20g, tprd., str.	10/Box
TE-9032A	Vitreoretinal Cann. [Vander] 20g, tprd., angld.	10/Box
TE-9033	Subretinal Injector [Glaser] 20g, tapered, curved	10/Box
TE-9034	Subretinal Injector [Glaser] 20g, tapered, straight	10/Box
TE-9035	MVR Cannula [Glaser] 20g, tapered angled	10/Box
TE-9036	Subretinal Cannula [Lambert] 20g, tapered, curved	10/Box

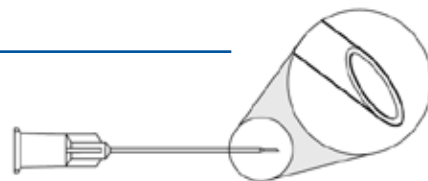

Lasik Cannulas

PRODUCT NO.	DESCRIPTION	QTY PER BOX
TE-9901D	[Dishler] Lasik Cannula 27g	10/Box
TE-9902S	[Slade] Lasik Cannula 26g	10/Box
TE-9903L	[Linstrom] Lasik Cannula 25g	10/Box
TE-9903-9	[Linn] Lasik Cannula 25g	10/Box
TE-9903V	[Vidaurri] Lasik Cannula 25g	10/Box
TE-9903-8FSP	[Solomon] Lasik Cannula 25g	10/Box

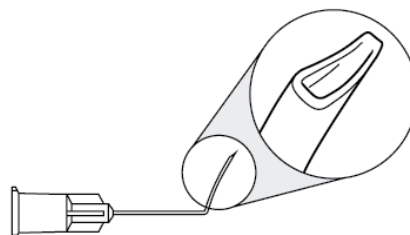
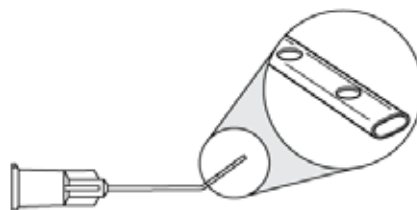
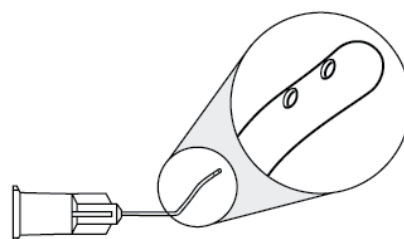

SolarShield® Post-Cataract Surgery Sunglasses

Complete protection for post-cataract surgery



- Comfortable fit
- Lightweight frame
- Polycarbonate lenses
- Provide 48% more protection from sunlight than ordinary sunglasses
- 100% UVA/UVB protection

SolarShield® Fits Over™ Sunglasses



PRODUCT NO.	DESCRIPTION	QTY/BOX
29005A	Sunglasses in Smoke, Includes black Microfiber case	144
29005M	Sunglasses in Smoke, Includes protective foam	144



PRODUCT NO.	DESCRIPTION	QTY/BOX
29010A	Sunglasses in Clear, Includes black drawstring case	144



PRODUCT NO.	DESCRIPTION	QTY/BOX
29008A	Sunglasses in Amber, Includes black drawstring case	144



PRODUCT NO.	DESCRIPTION	QTY/BOX
29009A	Sunglasses in Yellow, Includes black drawstring case	144

Post-Cataract Surgery Kits with SolarShield® Sunglasses

Complete protection for post-cataract surgery

Post Cataract Kits

- Kits shown are the most popular options
- Custom kits available, please inquire
- Custom printing available on select bags
- Microfiber sleeves are available



PRODUCT NO.	DESCRIPTION	QTY/BOX
TE-671Y	<ul style="list-style-type: none"> • 29005M SolarShield® Fits Over™ Sunglasses with foam case • Transpore® or Micropore® Tape • Plastic Drawstring Bag 	100



PRODUCT NO.	DESCRIPTION	QTY/BOX
TE-671X	<ul style="list-style-type: none"> • 29005M SolarShield® Fits Over™ Sunglasses with foam case • Transpore® or Micropore® Tape • Encore® Single Eyeshield • Plastic Drawstring Bag 	100



PRODUCT NO.	DESCRIPTION	QTY/BOX
TE-671A	<ul style="list-style-type: none"> • 29005A SolarShield® Fits Over™ Sunglasses with black microfiber case • Half-eye Reading Glasses • Transpore® or Micropore® Tape • Encore® Single Eyeshield • Navy Blue Zipper Bag 	100

BAG OPTIONS:



Clear Vinyl Zipper Bag



Navy Blue Zipper Bag



Drawstring Bag

SolarComfort® Post-Refractive Surgery Sunglasses

Complete protection for post-refractive surgery



- Worn alone
- Lightweight, full coverage frames
- Ideal for dry-eye people
- Protective vinyl string case included
- 100% UVA/UVB protection

SolarComfort® Sunglasses



PRODUCT NO.	DESCRIPTION	QTY/BOX
6706A	Sunglasses in Smoke tint, Includes black microfiber case	144
6706M	Sunglasses in Smoke tint , Includes protective foam case	144



PRODUCT NO.	DESCRIPTION	QTY/BOX
6707A	Sunglasses in Amber, Includes black drawstring case	144



PRODUCT NO.	DESCRIPTION	QTY/BOX
6708A	Sunglasses in Clear, Includes black drawstring case	144



PRODUCT NO.	DESCRIPTION	QTY/BOX
6709A	Sunglasses in Yellow, Includes black drawstring case	144

Post-Refractive Surgery Kits with SolarComfort® Sunglasses

Complete protection for post-refractive surgery

Post-Refractive Kits

- Kits shown are the most popular options
- Custom kits available, please inquire
- Custom printing available on select bags
- Microfiber sleeves are available



PRODUCT NO.	DESCRIPTION	QTY/BOX
TE-672X Economy	<ul style="list-style-type: none"> • 6706M SolarComfort® Sunglasses with foam case • Encore® Clear Dual Eyeshield • Plastic Drawstring Bag 	100

PRODUCT NO.	DESCRIPTION	QTY/BOX
TE-672K Premium	<ul style="list-style-type: none"> • 6706A SolarComfort® Sunglasses with Black Microfiber Case • Encore® Clear Dual Eyeshield • Navy Blue Zipper Bag 	100

BAG OPTIONS:



Clear Vinyl Zipper Bag

Navy Blue Zipper Bag

Drawstring Bag

Dual Eyeshields, Goggles & Single Eyeshields

Complete protection for post lasik and cataract patients

Encore® Dual Eyeshield



5818D



5819D

Designed to be worn at night by post LASIK and cataract patients for maximum comfort & protection. Increases all-around optical visibility.

- Adjustable to fit all head sizes
- Latex free
- Made of polycarbonate and durable single-cell foam

PRODUCT NO.	DESCRIPTION	QTY/BOX
5818D	Clear Encore® Dual Eyeshield	300
5819D	Smoke Encore® Dual Eyeshield with UV Protection	300

Encore® Goggle Eyeshield



5820GS



5821GC

Polycarbonate lenses provide maximum protection and comfort for dry eye & post operative patients

- Adjustable head strap
- Latex free
- Hinged nose bridge provides added comfort
- Durable foam on shield is slip proof & comfortable

PRODUCT NO.	DESCRIPTION	QTY/BOX
5820GS	Smoke Encore® Goggle Eyeshield with UV Protection	250
5821GC	Clear Encore® Goggle Eyeshield with UV Protection	250

Dual Eyeshields, Goggles & Single Eyeshields

Complete protection for post lasik and cataract patients

Encore® Single Eyeshield



5702CS



5703CS

Polycarbonate allows for maximum comfort and protection for post-operative patients

- Center design provides maximum optical clarity
- Specially designed ventilation prevents fogging

PRODUCT NO.	DESCRIPTION	QTY/BOX
5702CS	Clear Encore® Single Eyeshield	100
5703CS	Smoke Encore® Single Eyeshield	100
TE-501040	Clear Single Eyeshield, Sterile	50

Encore® Two-piece Eyeshield



5824MS

Polycarbonate lenses provide maximum protection and comfort for post-operative patients

- Adjustable head strap
- Durable foam is slip proof and comfortable
- Latex free
- Ventilated to reduce fogging

PRODUCT NO.	DESCRIPTION	QTY/BOX
5824MS	Clear Encore® Two-Piece with Strap	300

Encore® Moisture Retention Chamber

Encore® Moisture Retention Chamber.....



Designed to be worn at night to retain moisture for dry eye

- Adjustable to fit all head sizes
- Made of polycarbonate and durable single-cell foam
- Latex free

PRODUCT NO.	DESCRIPTION	QTY/BOX
5822MS	Clear Encore® Moisture Retention Chamber	300

Diagnostic Strips

PRODUCT NO.	DESCRIPTION	QTY/BOX
2000	BioGlo™, Sterile Fluorescein Sodium Strips	100/box
2002	BioGlo™, Sterile Fluorescein Sodium Strips	300/box

Notes

Notes

Tecfen Medical
5385 Hollister Avenue
Santa Barbara, CA 93111 U.S.A.

T: +1 805 967 1153
F: +1 805 967 1295
tecfen@tecfen.com
www.tecfenmedical.com